

Sirocco Fans General Catalog

TERAL

CLF

50Hz



TERAL INC.

■ Uses

General

- Ventilation and air-conditioning of buildings, condominiums, hospitals, schools, restaurants, complexes, etc.
- Air blow/exhaust, and cooling of various devices
- Boilers and dryers
- Ventilation of factories, warehouses, car parking garages, and underground malls
- General air blow/exhaust

CLF6-OB model and CLFII-OB model

- Air exhaust of kitchens and toilets

CLFII-OB model (gas contact parts made of SUS304)

- Exhaust of high-humidity gases
- Exhaust of gases containing some corrosive gases

■ Features

HOH type

- While being compact, it is high in air volume, and does not require a large installation area as the impeller is attached to the motor shaft.
- With little vibration, operation is quiet as it is directly driven by the motor.

RS type, OB type, and RD type

- These are high-efficiency types that deliver great performance using low power.
- Optimum selection can be made appropriately due to many rotation speeds.
- Installation is easy as they are designed to be as compact as possible.
- Sufficient performance is delivered at low rotation speed with noise generation reduced.

■ Model type description

CLF6 - No.2 - TH - R - RS - D

- ① ② ③ ④ ⑤ ⑥

- ① Sirocco fan CLF6 model, CLF5 model, CLFII model
- ② Fan number
- ③ Discharge direction
TH : Top horizontal, TV : Top vertical, BH : Bottom horizontal
TUS : Top oblique 45°, BV : bottom vertical
- ④ Rotation direction (motor viewed from the pulley side)
R : Clockwise, L : Counter-clockwise
- ⑤ Power transmission method
HOH-S : Motor direct driven type without coupling
RS : Belt driven (single inlet, straddle mounted impeller (overhang mounted impeller) type)
OB : Belt driven (single inlet, overhang mounted impeller type)
UOB : Belt driven (single inlet, overhang mounted impeller type)
RD : Belt driven (double inlet, straddle mounted impeller type)
- ⑥ Installation method
None : Standard (HOH type only)
B : Standard (RS type, OB type, and RD type)
A : No common base (RS type, OB type, and RD type)
D : floor, anti-vibration type
I : ceiling-suspended, anti-vibration type
ND : floor, anti-vibration type (with earthquake-resistant stopper bolt)
KI : ceiling-suspended, anti-vibration type (with earthquake-resistant stopper bolt)
NI : ceiling-suspended, anti-vibration type (with earthquake-resistant cage type stopper bolt)

Performance data of fans are measurements obtained based on JIS B 8330: Testing and Inspection Methods for Fans.
All the performance curves in this catalog are indicated under standard conditions (air at a temperature of 20°C, an absolute pressure of 101.3kPa, and a relative humidity of 65%). Therefore, for handling gases at temperatures other than 20°C, make a selection according to the pressure obtained by the following calculation formula.

$$P' = P \times \frac{\text{Absolute temperature} + t}{\text{Absolute temperature} + 20} = P \times \frac{273 + t}{293}$$

P' : Static pressure to be applied to the performance table (static pressure at 20°C) Pa
P : Static pressure required at t°C Pa
t : Suction air temperature °C

When the suction air temperature drops below 20°C, take 3.5% at 10°C and 7.5% at 0°C with respect to the motor output in the catalog.

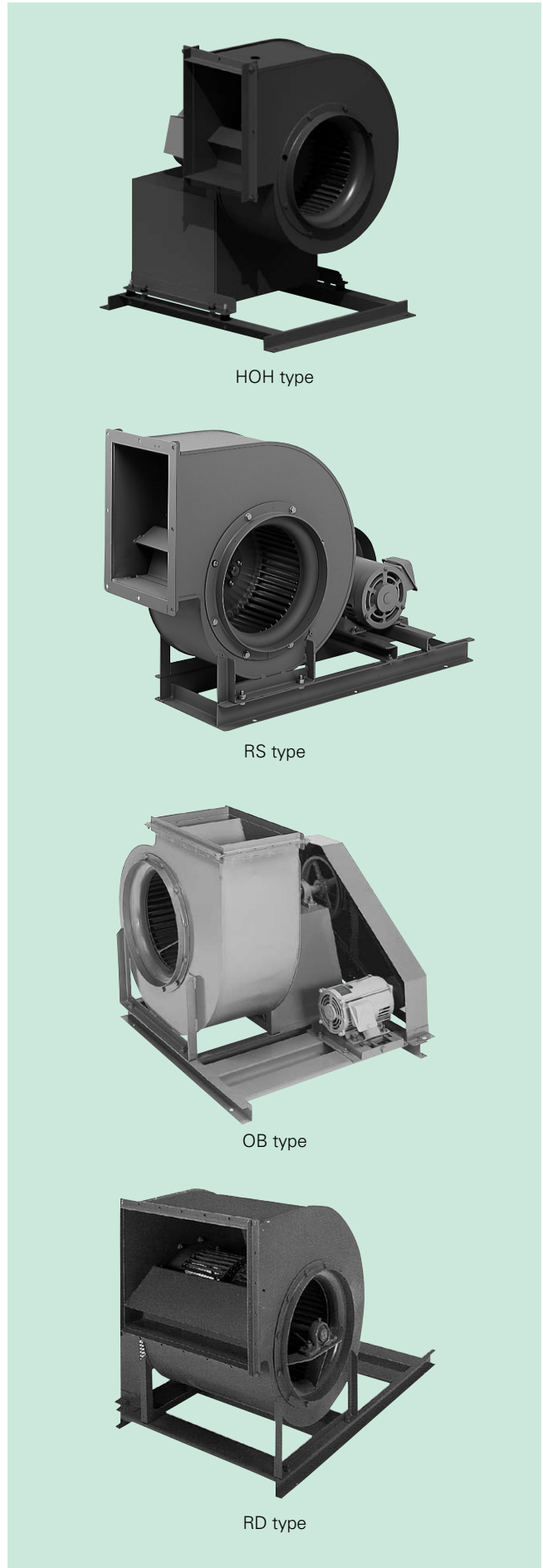

HOH type

RS type

OB type

RD type

* Keep in mind that the above show typical examples, part of which may differ from actual devices.

■ Discharge rotation and direction (viewed from the motor side)

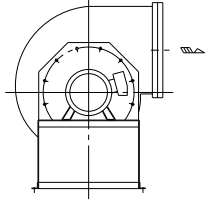
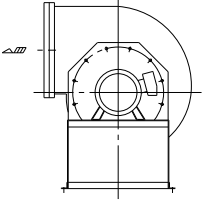
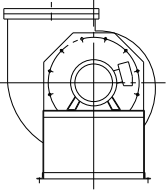
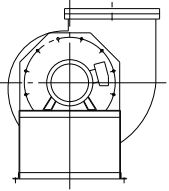
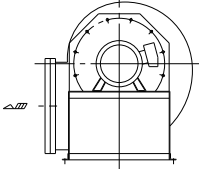
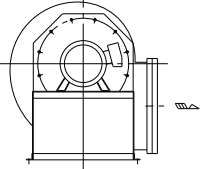
	R (clockwise)	L (counter-clockwise)
1	TH-R (top horizontal discharge)	TH-L (top horizontal discharge)
		
2	TV-R (top vertical discharge)	TV-L (top vertical discharge)
		
3	BH-R (bottom horizontal discharge)	BH-L (bottom horizontal discharge)
		

■ Discharge rotation and direction (viewed from the pulley side)

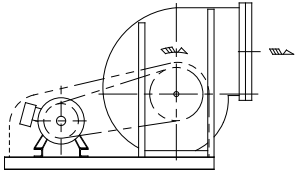
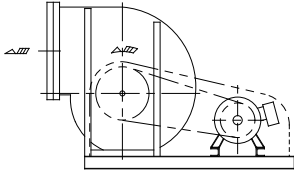
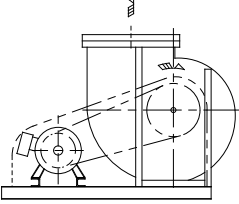
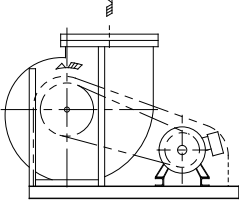
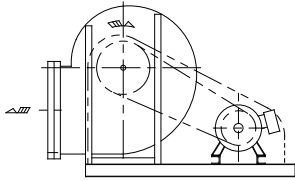
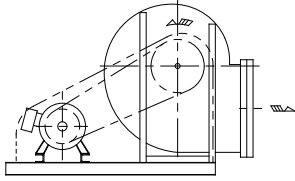
	R (clockwise)	L (counter-clockwise)
1	TH-R (top horizontal discharge)	TH-L (top horizontal discharge)
		
2	TV-R (top vertical discharge)	TV-L (top vertical discharge)
		
3	BH-R (bottom horizontal discharge)	BH-L (bottom horizontal discharge)
		

Standard specifications, special specifications, standard accessories, and special accessories

● standard specification, ◎ special specification, — unsupported

Model	CLF6-HOH	CLF6-RS	CLF5-RS	CLFII-RS	CLF6-OB	CLFII-OB	CLF6-UOB	CLFII-UOB	CLFII-RD	
Fan number	No.1~2½	No.1~2½	No.3~4	No.4½~10	No.1~3	No.1~10 ^{*3}	No.1~3 ^{*22}	No.3½~6 ^{*23}	No.2~10	
Power transmission method	Motor direct driven type with coupling (single inlet)	●	—	—	—	—	—	—	—	
	Belt driven type	Single inlet, straddle mounted impeller type	—	—	●	●	—	—	—	—
		Single inlet, overhang mounted impeller type	—	●	—	—	●	●	●	—
		Double inlet, straddle mounted impeller type	—	—	—	—	—	—	—	●
Temperature of gas handled	0 ~ 40°C	●	●	●	●	●	●	●	●	
	41 ~ 90°C	—	—	—	—	●	●	●	—	
	91 ~ 150°C (radiator plate type)	—	—	—	—	◎ ^{*18}	◎ ^{*18}	◎	—	
	151 ~ 200°C (radiation blade type)	—	—	—	—	◎ ^{*18}	◎ ^{*18}	◎	—	
	201 ~ 250°C (air cooled type)	—	—	—	—	◎ ^{*18}	◎ ^{*18}	◎	—	
Casing	Impeller	●	●	●	●	●	●	●	●	
	Bearing	Sealed bearing	—	●	—	—	—	—	—	—
		Pillow type unit	—	—	●	●	● ^{*15}	●	● ^{*15}	●
		UKP type	—	—	◎	◎	—	◎	—	◎ ^{*8}
		Lubrication piping	—	—	◎	◎	◎	◎	◎	◎
	Inlet	—	◎	◎	◎	◎	◎	◎	◎	
	Shaft seal	—	—	—	—	◎	◎	◎	◎	
	Companion flange	Companion flange (discharge) ^{*1}	●	●	●	●	●	●	●	●
		Companion flange (suction) ^{*1}	●	●	●	●	●	●	●	—
	Drain	Drain (hole)	●	●	●	—	—	—	—	—
		Drain (socket mounted) ^{*19}	◎	◎	◎	●	◎ ^{*17}	◎ ^{*17}	●	●
		Drain (socket mounted): with cock/valve	◎	◎	◎	◎	◎ ^{*18}	◎ ^{*18}	◎	◎
	Inspection opening	Bolt and nut fastening	◎	◎	◎	◎	◎	◎	◎	◎
		One-touch type	—	—	◎	◎	◎ ^{*21}	◎ ^{*21}	◎ ^{*21}	◎
	Special discharge direction	Bottom vertical (BV), top oblique 45° (TUS), bottom oblique 45° (BUS)	—	—	—	◎	◎	◎	◎	◎
Vertical split		—	—	—	◎ ^{*2}	—	◎ ^{*2}	◎ ^{*2}	◎ ^{*2}	
Bearing guard	Standard	—	—	—	—	●	●	◎	—	
	Enclosed (with inspection opening)	—	—	—	—	◎	◎	◎	—	
	With acrylic inspection opening	—	—	—	—	◎	◎	—	—	
	With one-touch inspection opening	—	—	—	—	◎	◎	—	—	
	Expanded metal spec	—	—	—	—	◎	◎	—	—	
Belt guard	Standard	—	●	●	●	●	●	●	●	
	Enclosed (with back cover)	—	◎	◎	◎	◎	◎	◎	◎	
	With rotation speed measuring hole	—	◎	◎	◎	◎	◎	◎	◎	
	With inspection opening	—	◎	◎	◎	◎	◎	◎	◎	
	With acrylic inspection opening	—	◎	◎	◎	◎	◎	◎	◎	
	With one-touch inspection opening	—	◎	◎	◎	◎	◎	◎	◎	
	Expanded metal spec	—	◎	◎	◎	◎	◎	◎	●	
	Vertical split	—	◎ ^{*20}	◎	◎	◎ ^{*20}	◎ ^{*20}	◎ ^{*20/25}	◎ ^{*25}	
Child finger protection spec	—	◎ ^{*20}	◎	◎	◎ ^{*20}	◎ ^{*20}	◎ ^{*20}	◎ ^{*20}		
Suction wire mesh	Standard material	◎	◎	◎	◎	◎	◎	◎	◎	
	SUS304	◎	◎	◎	◎	◎	◎	◎	◎	
With sound-muffling box	Indoor installation	◎	● (CLF6-U-RS type)	● (CLF5-U-RS type)	◎ ^{*16}	◎	◎ ^{*16}	—	● ^{*8} (CLFII-U-RD type)	
	Outdoor installation	◎	◎	◎	◎ ^{*16}	◎	◎ ^{*16}	—	◎	
	With earthquake-resistant stopper bolt	◎	◎	◎	◎	◎	◎	—	◎	
	Change to glass wool 40K	◎	◎	◎	◎	◎	◎	—	◎	
	Change to water-repellent glass wool	◎	◎	◎	◎	◎	◎	—	◎	
Upward pull	—	◎	◎	◎	◎	◎	—	◎		
V-belt red seal	—	◎	◎	◎	◎	◎	◎	◎		
Material	Casing...SPHC,SPCC,SS400	●	●	●	—	—	—	—	—	
	Impeller...SGCC,SGHC	●	●	●	—	—	—	—	—	
	Shaft...S45C (S35C motor shaft for HOH type)	—	—	—	●	●	●	●	●	
	Casing, impeller...SPHC,SPCC, Shaft...S45C	—	—	—	—	—	◎ ^{*4}	—	◎ ^{*4}	
	Casing, impeller, shaft...SUS304(gas contact parts SUS304)	—	—	—	—	—	◎ ^{*27}	—	◎ ^{*27}	
Other than gas contact parts SUS304 ^(※26)	—	—	—	—	—	◎ ^{*27}	—	◎ ^{*27}		
Installation location	Indoors (ambient temperature 0 ~ 40°C, relative humidity 85% or less)	●	●	●	●	●	●	●	●	
	Outdoors	◎	◎	◎	◎	◎	◎	◎	—	

● standard specification, ◎ special specification, — unsupported

Model	CLF6-HOH	CLF6-RS	CLF5-RS	CLFII-RS	CLF6-OB	CLFII-OB	CLF6-UOB	CLFII-UOB	CLFII-RD	
Fan number	No.1~2½	No.1~2½	No.3~4	No.4½~10	No.1~3	No.1~10 ^{※3}	No.1~3 ^{※22}	No.3½~6 ^{※23}	No.2~10	
Installation method	Floor type (B)	●	●	●	●	●	●	●	●	
	Anti-vibration floor type (D · ND) ^{※5}	◎	◎	◎	◎	◎	◎	◎	◎	
	Ceiling-suspension type (G · I · KI)	◎	◎	◎	◎ ^{※7}	◎	◎ ^{※8}	◎ ^{※8}	◎ ^{※8}	
	Anti-vibration ceiling-suspension type (NI : earthquake-resistant cage type) ^{※6}	◎	◎	◎	◎ ^{※7}	◎	◎ ^{※8}	◎ ^{※8}	◎ ^{※8}	
Motor	Totally-enclosed-fan-cooled indoor type (15kW or less)	●	●	●	●	●	●	●	●	
	Drip-proof protected type (18.5kW or more) 3φ 200V	●	●	●	●	●	●	●	●	
	Totally-enclosed-fan-cooled indoor type (18.5kW or more), Totally-enclosed-fan-cooled outdoor type	◎	◎	◎	◎	◎	◎	◎	◎	
	Different voltage	◎	◎	◎	◎	◎	◎	◎	◎	
	Single phase	◎	—	—	—	—	—	—	—	
	High-efficiency type	◎	◎	◎	◎	◎	◎	◎	◎	
	Increased-safety explosion-proof type and pressure-proof type	◎	◎	◎	◎	◎	◎	◎	◎	
Coating ^{※9}	Polyester urethane based powder coating 7.5BG5/1.5	● ^{※11}	● ^{※11}	● ^{※11}	—	—	—	—	—	
	Priming and inner surface...Rust-preventing paint (alkyd resin based)	—	—	—	● ^{※12}	● ^{※12}	● ^{※12}	● ^{※12}	● ^{※12}	
	Outer surface overcoating...Acrylated alkyd resin coating 7.5BG5/1.5	—	—	—	● ^{※12}	● ^{※12}	● ^{※12}	● ^{※12}	● ^{※12}	
	Epoxy resin coating ^{※10}	Inner surface only	◎	◎	◎	◎	◎	◎	◎	◎
		Both inner and outer surfaces	◎	◎	◎	◎	◎	◎	◎	◎
	PVC coating	Inner surface only	◎	◎	◎	◎	◎	◎	◎	◎
		Both inner and outer surfaces	◎	◎	◎	◎	◎	◎	◎	◎
	Coating against salt damage	Inner surface only	◎	◎	◎	◎	◎	◎	◎	◎
		Both inner and outer surfaces	◎	◎	◎	◎	◎	◎	◎	◎
	Heat-resistant silver coating	—	—	—	—	◎ ^{※13}	◎ ^{※13}	◎ ^{※13}	◎ ^{※13}	—
Coating color designation	Overall	◎	◎	◎	◎	◎	◎	◎	◎	
	Covers only	—	◎	◎	◎	◎	◎	◎	◎	
Common base (B/D base) hot-dip galvanizing	◎ ^{※24}	◎	◎	◎	◎	◎	◎ ^{※24}	◎ ^{※24}	◎	

- ※1 OB type is not provided with duct fixing rivet holes. Types other than OB are provided with rivet holes.
- ※2 Supported only for No. 4½ or higher. (No. 10 is vertical split type as a standard.)
- ※3 As for No.1 – 3, gas contact parts are made of SUS. Those made of SS are supported by CLF6-OB model.)
- ※4 Materials of designated parts can be changed. (For example, the impeller alone is made of SUS304; the case is made of SPHC, SS400; and the shaft is made of S45C.)
- ※5 Anti-vibration rubber mount, combination spring anti-vibration rubber mount, and anti-vibration spring mount can be supported. They can also come with earthquake-resistant stopper bolts.
- ※6 Anti-vibration rubber mount, combination spring anti-vibration rubber mount, and anti-vibration spring mount can be supported. They can also come with earthquake-resistant stopper bolts. Anti-vibration rubber hangers and anti-vibration spring hangers can also be supported.
- ※7 Supported only for No. 4½ or lower.
- ※8 Supported only for No. 4 or lower.
- ※9 Motors are in accordance with motor manufacturers' coating.
- ※10 Epoxy resin coating cannot be installed outdoors. Comparable corrosion resistance required in outdoor installation is supported by coating against salt damage.
- ※11 Impellers are uncoated in principle (in the case of standard coating).
- ※12 Polyester urethane based powder coating 7.5BG5/1.5 is applied to some parts depending on fan number.
- ※13 If the temperature of gas handled exceeds 90°C, heat-resistant silver coating is applied.
- ※14 Parts of stainless steel material are uncoated in principle.
- ※15 Heat-resistant pillow block is used according to temperature classification.
- ※16 Supported only for No. 5 or lower.
- ※17 Welded structure of casing is drained (socket mounted) as a standard.
- ※18 Limited to welded structure of casing.
- ※19 They can also come with a specialized drain cock/valve. However, pay attention to the following for floor type. CLF6-HOH model, CLF6-RS model, CLF5-RS model, CLF6-OB model, and CLFII-OB model (No.1 – No.3) have no space to install a cock/valve because the drain socket is installed at the bottom of the casing. If drain piping is required, make an arrangement for the foundation.
- ※20 Unsupported for No. 2 or lower.
- ※21 Unsupported for No. 1½ or lower.
- ※22 Consideration is required for No. 1 – 1¾ as occasion arises. Supported for No. 2 – 3 within the motor output range in outline drawing.
- ※23 Supported within the motor output range in outline drawing.
- ※24 Common base (A/D).
- ※25 Horizontal split.
- ※26 Base, bearing stand, belt guard, and bearing guard are targeted.
- ※27 Supported only for No. 4 or lower. For No. 4½ or higher, contact us.

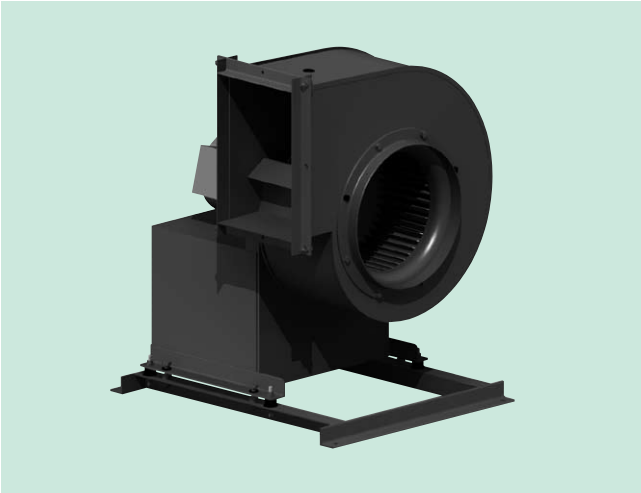

* Keep in mind that the above shows a typical example, part of which may differ from actual devices.

Performance drawing

Example of designation

No.2 2.2 - 4

Fan number Output (kW) No. of poles

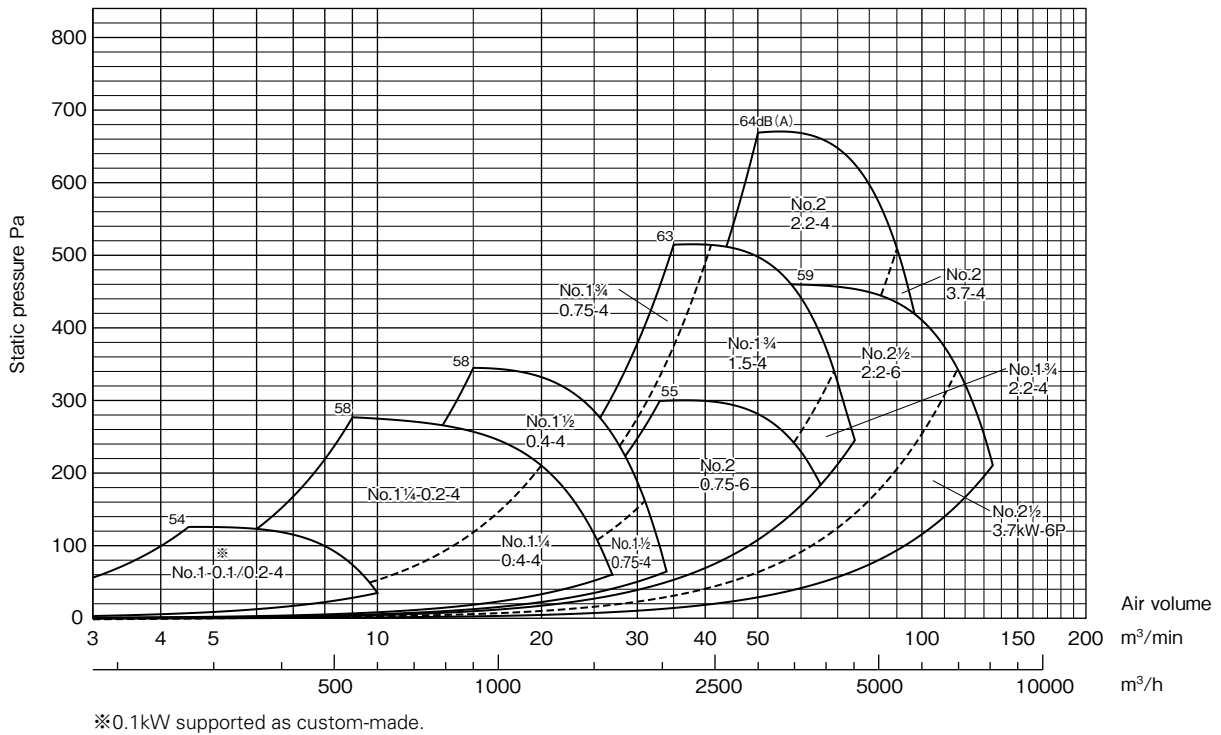

Noise measurement

Performance drawings show noise levels dB (A) in the vicinity 1.0m away from the main body in the following condition. Best efficiency point values of noise levels.

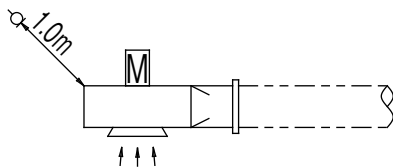

How to read performance drawings

- Open on the suction side and duct-connected on the discharge side
- Side sound levels 1.0m away from the main body
- Decibel db (A) scale display
- Best efficiency point values of noise levels

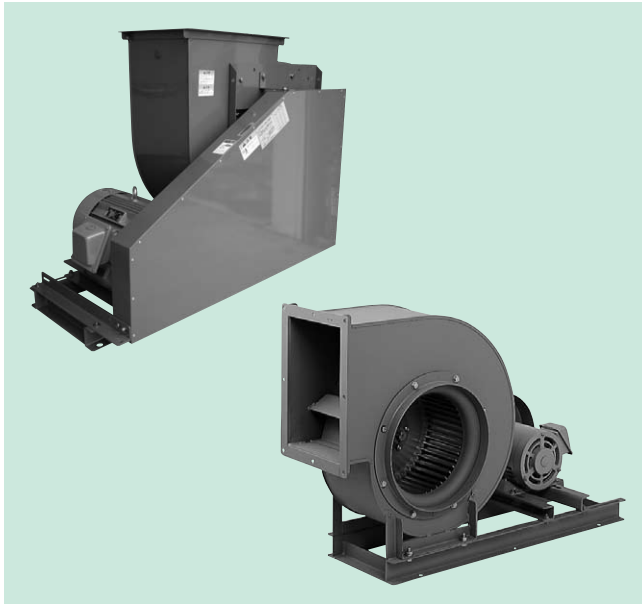
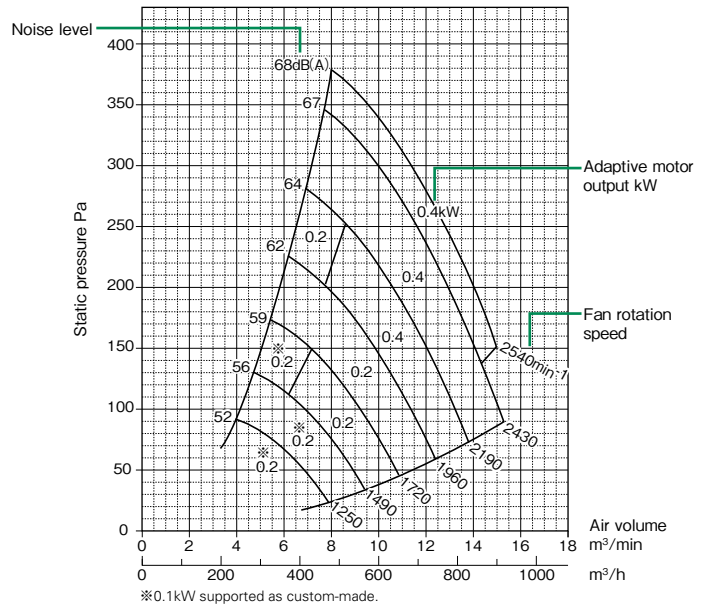
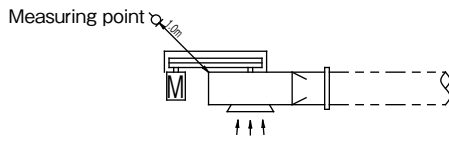

* Keep in mind that the above show typical examples of CLF5-RS model, part of which may differ from actual devices.

Performance drawing

No. 1

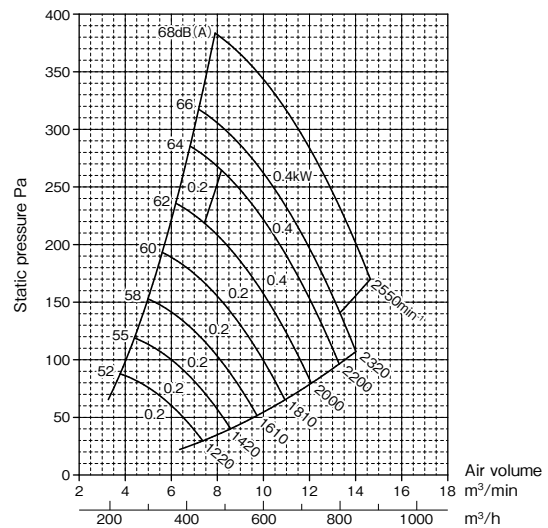

No. 1¼

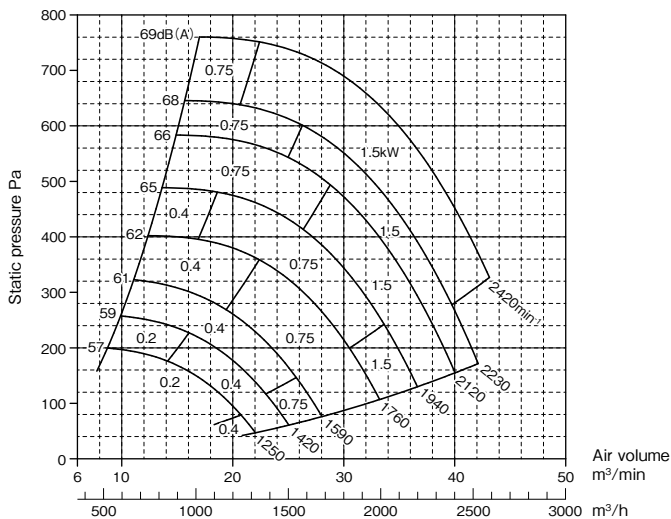

No. 1½

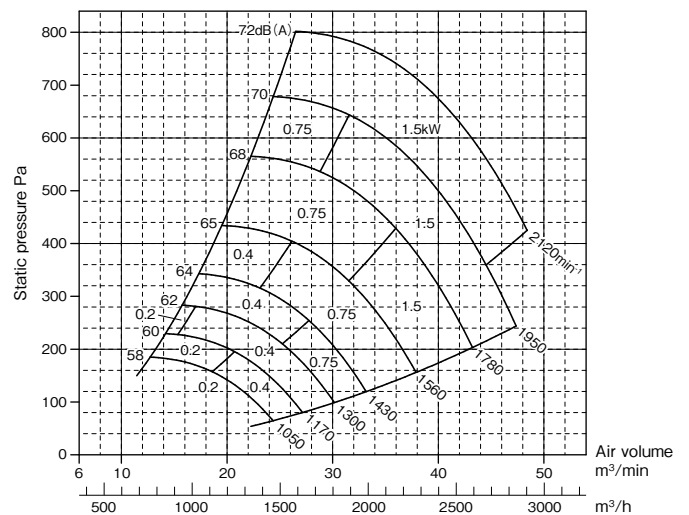

Performance drawing

CLF6-No.1¾

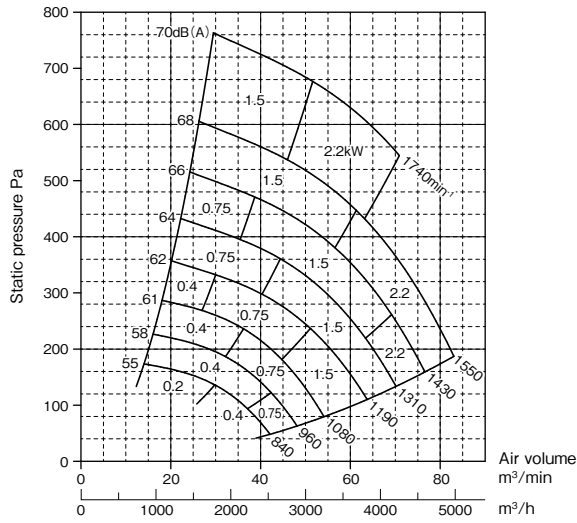

CLF6-No.2

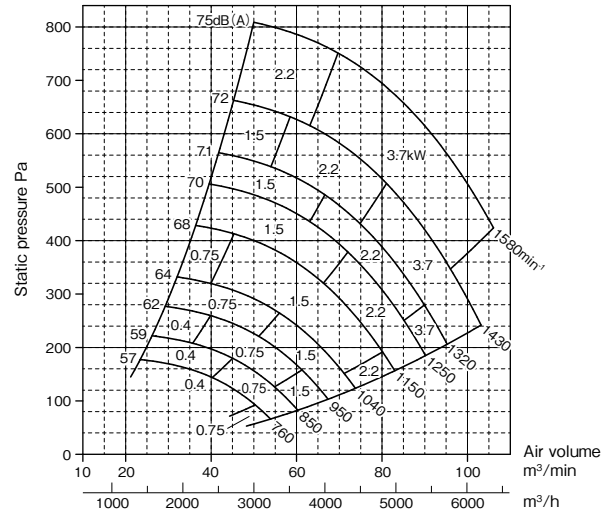

CLF6-No.2½

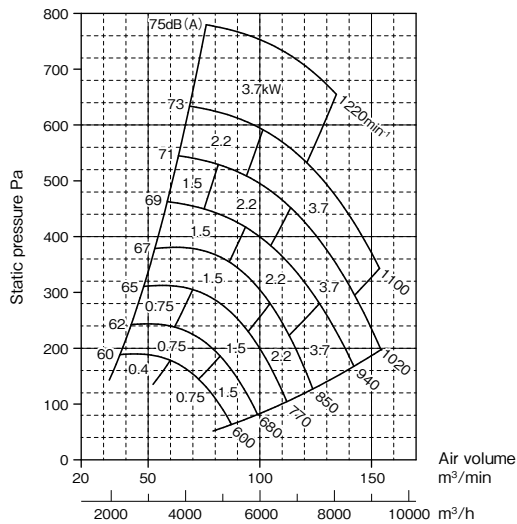

CLF5-No.3

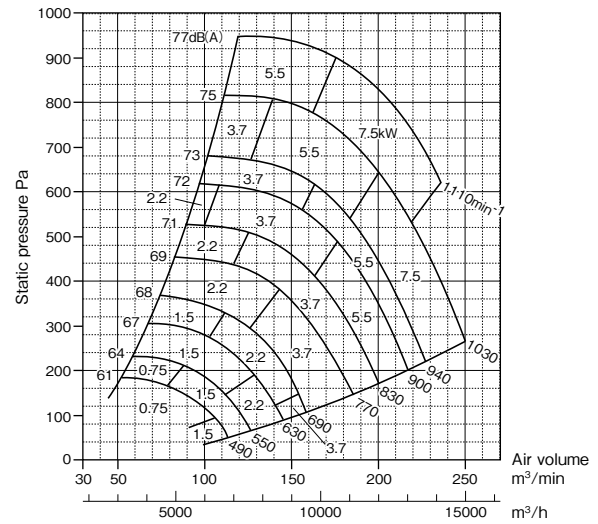

CLF5-No.3½

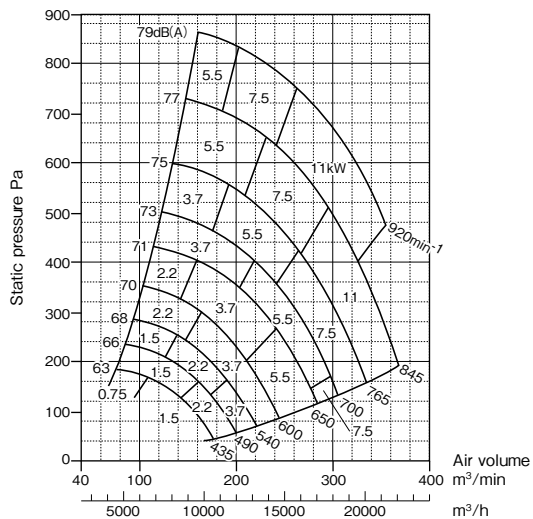

CLF5-No.4

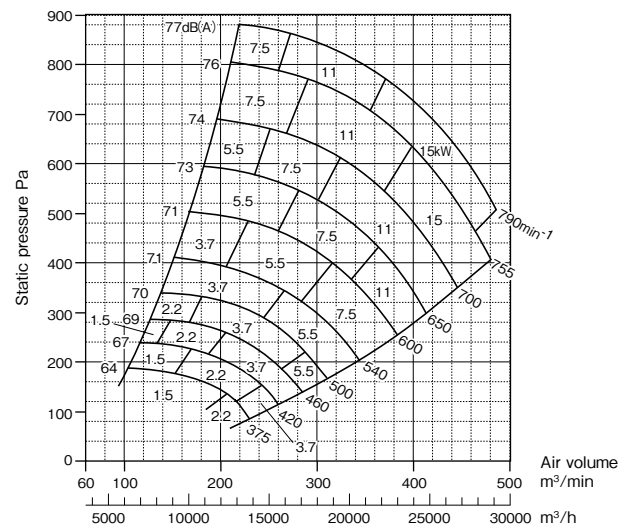

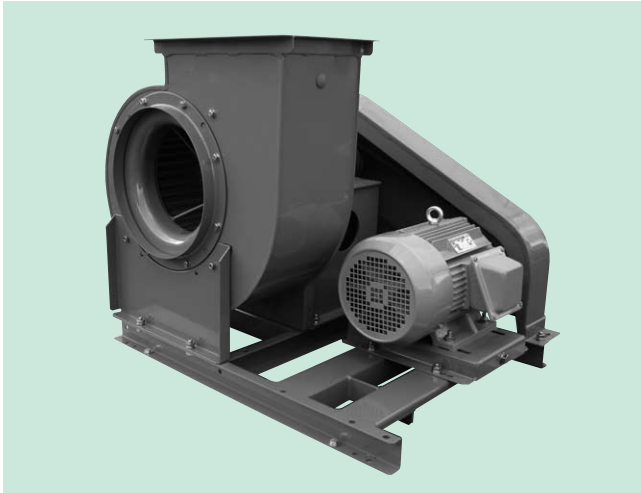

* Keep in mind that the above shows a typical example, part of which may differ from actual devices.

Performance drawing

No.1

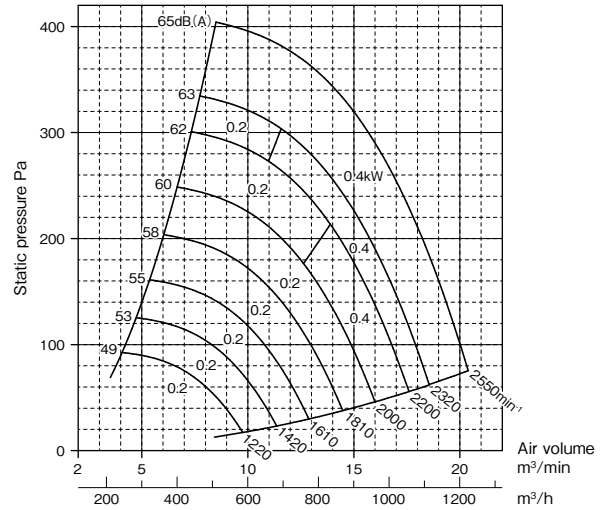

No.1¼

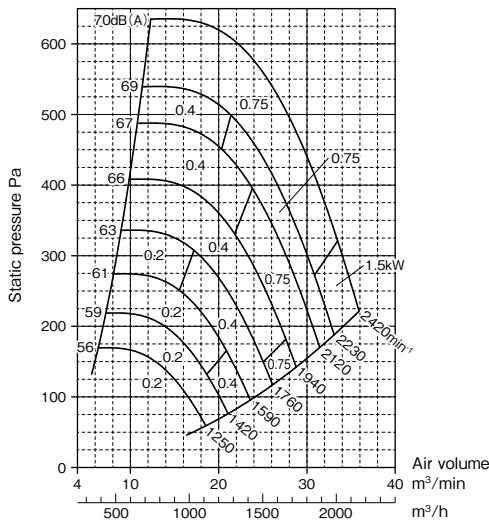

No.1½

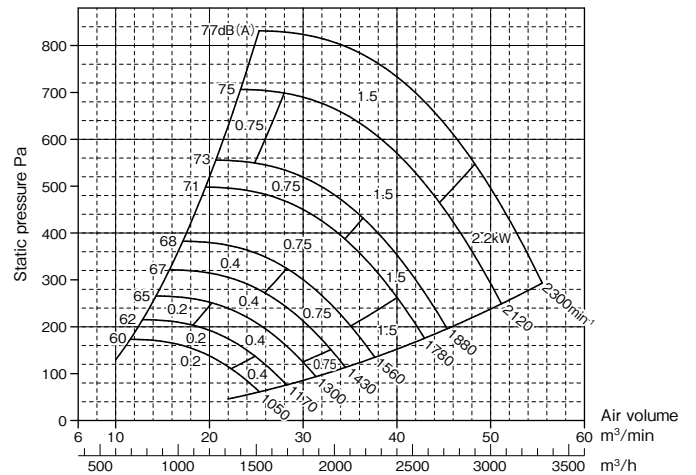

No.1¾

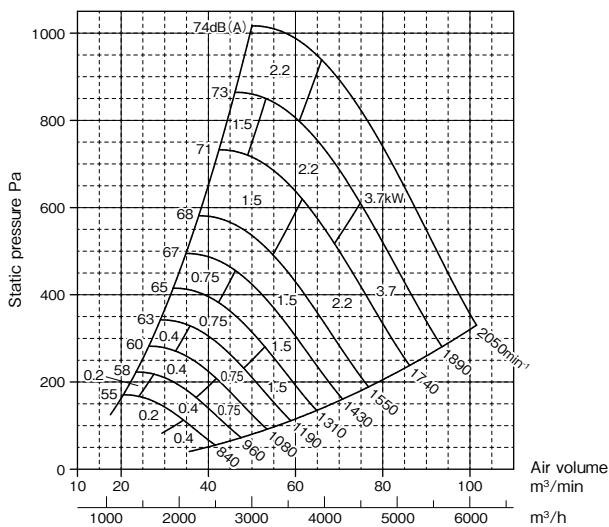

No.2

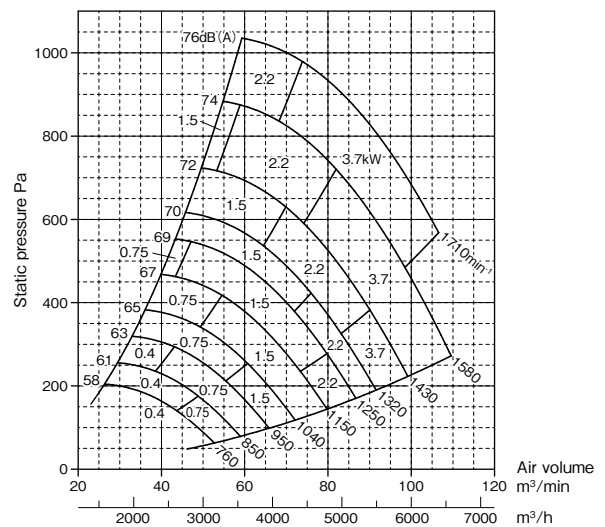

Performance drawing (CLF6-OB model)

No.2½

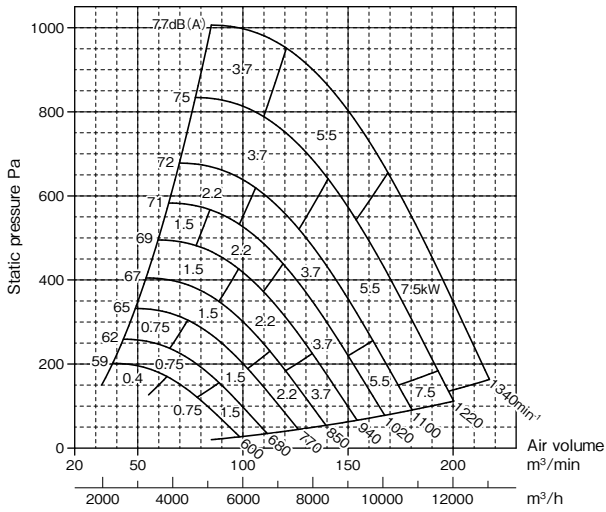

No.3

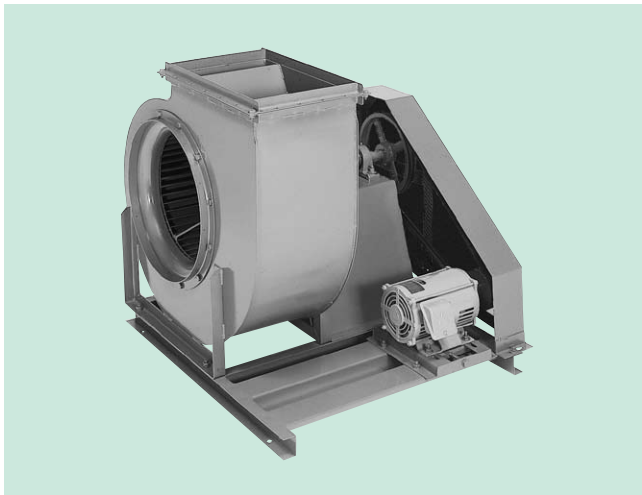
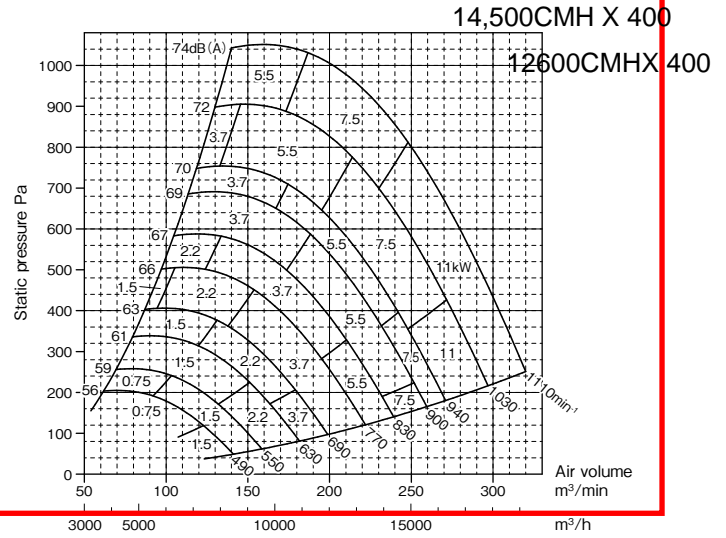

* Keep in mind that the above shows a typical example, part of which may differ from actual devices.

Performance drawing (CLFII-OB model)

No.3½

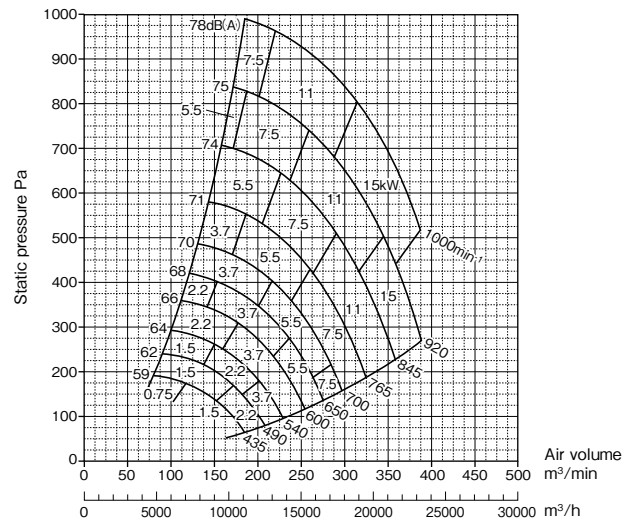

18,500 CMH X 450Pa

No.4

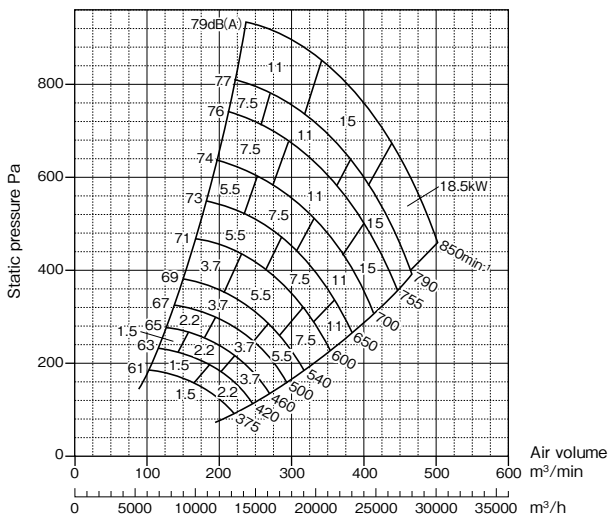

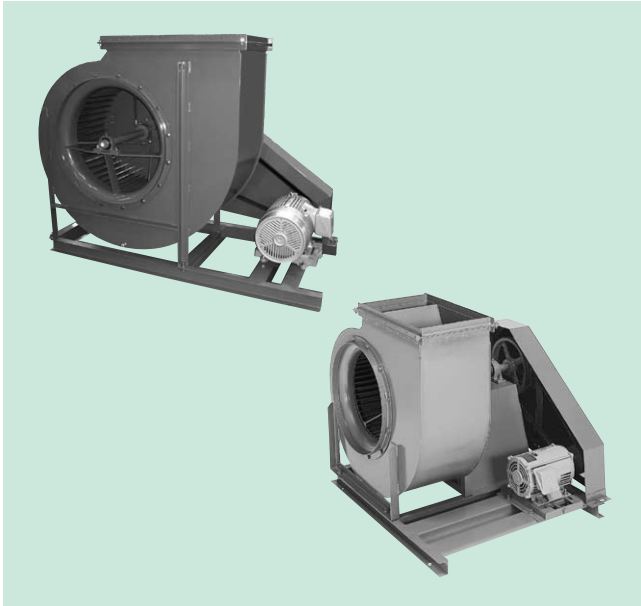

* Keep in mind that the above shows a typical example, part of which may differ from actual devices.

Performance drawing

* In performance drawings, rotation speeds in black and in green correspond to 4P and 6P, respectively, for the number of poles.

No.4½

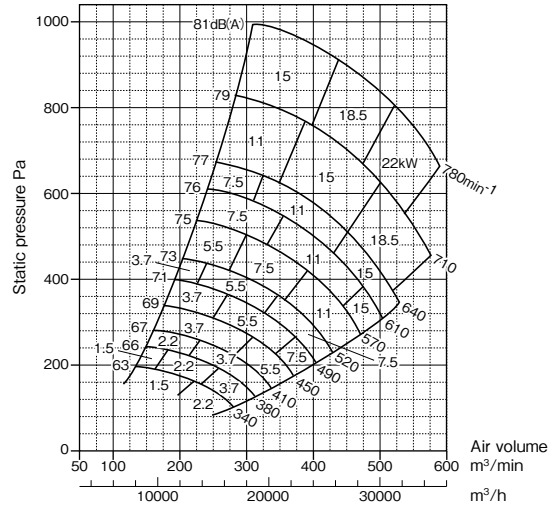

No.5

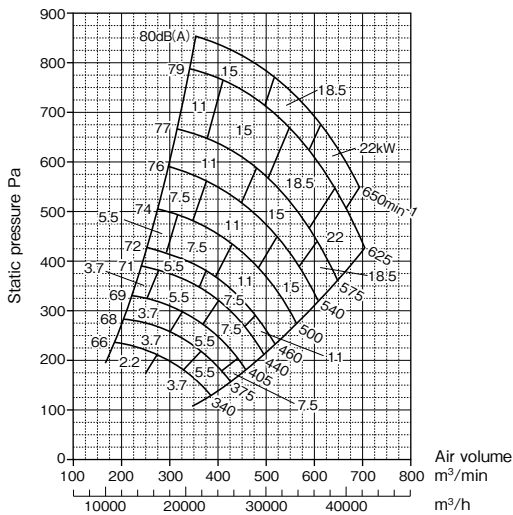

No.5½

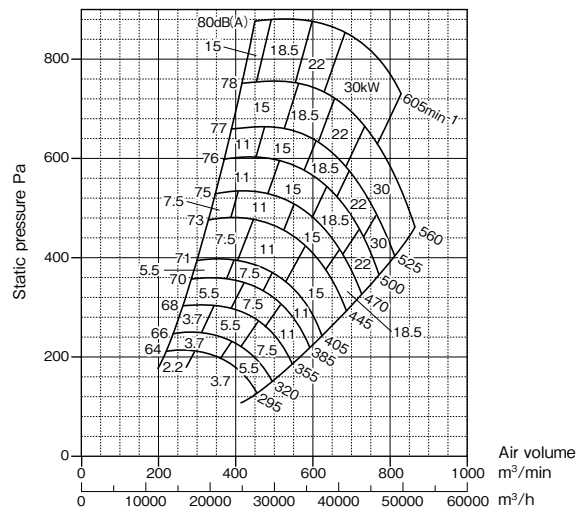

No.6

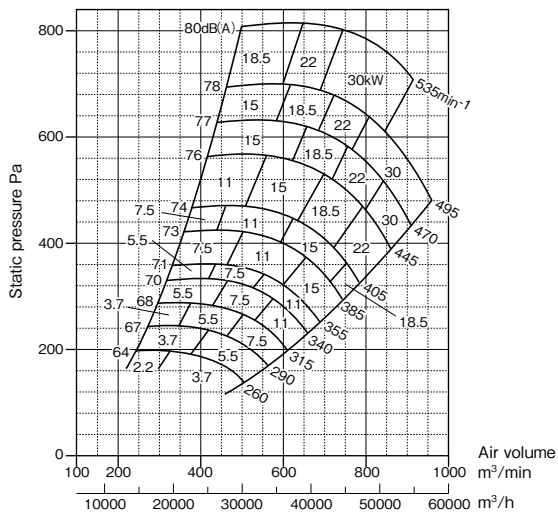

No.6½

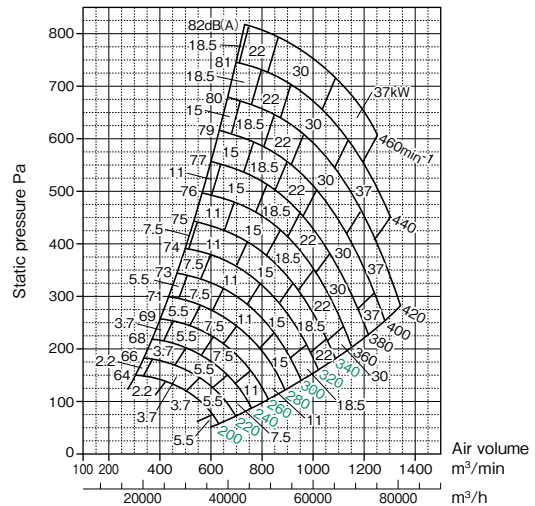

Performance drawing

*In performance drawings, rotation speeds in black and in green correspond to 4P and 6P, respectively, for the number of poles.

No.7

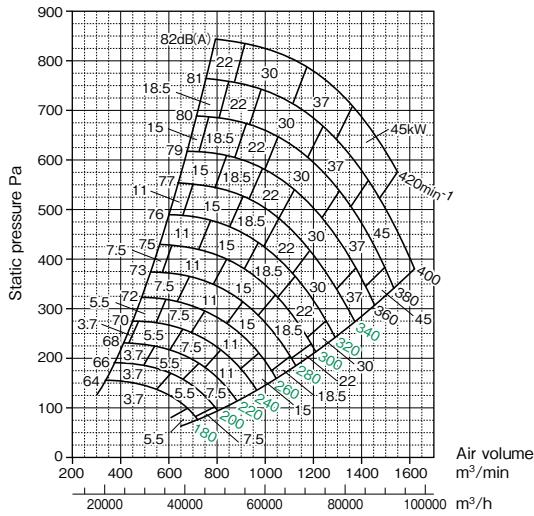

No.8

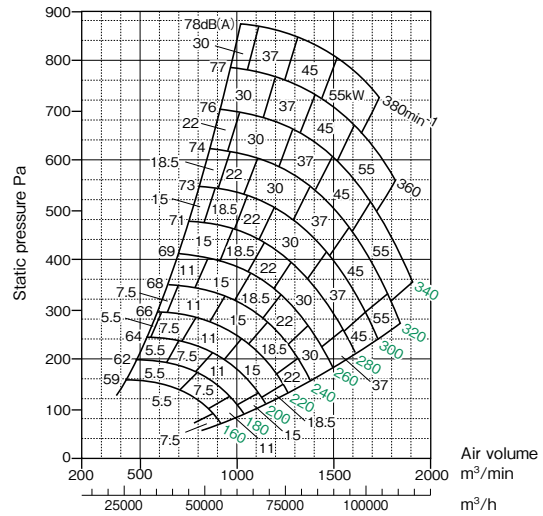

No.9

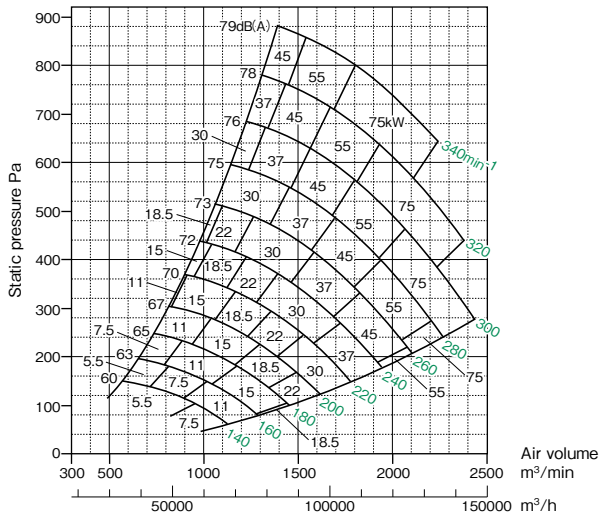

No.10

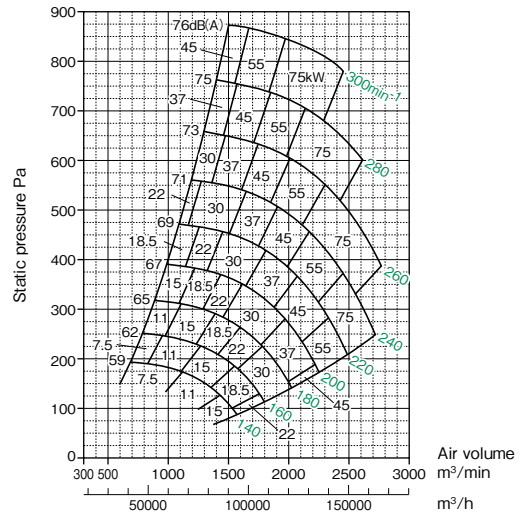

CLF II -OB model

Sirocco fans (multi-blade fans)
Single inlet, overhang mounted impeller, belt driven type
(Gas contact parts made of SUS)

Centrifugal fans

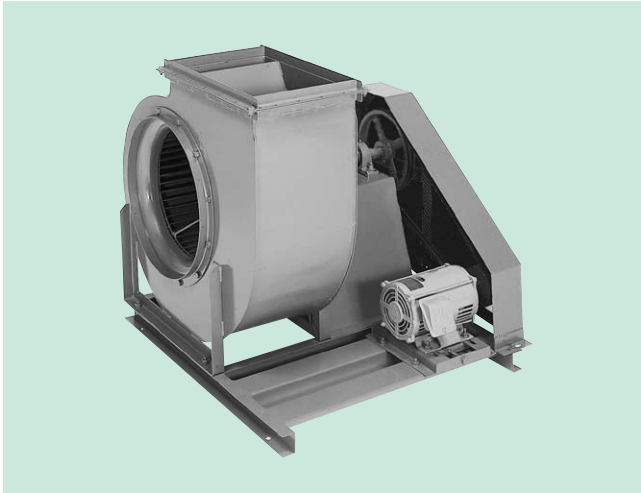

* Keep in mind that the above shows a typical example, part of which may differ from actual devices.

Performance drawing

No.1

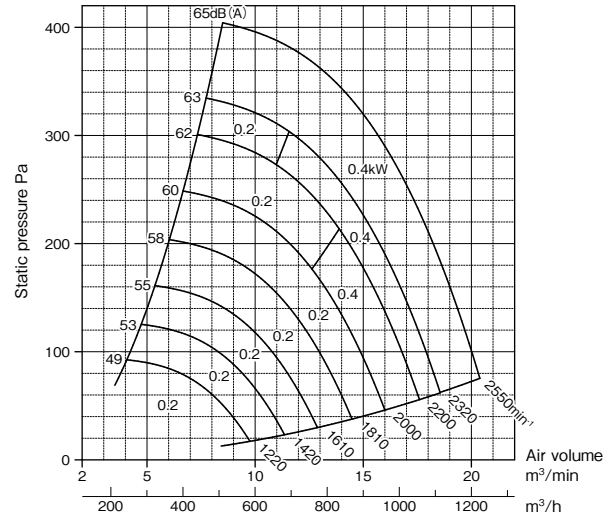

No.1¼

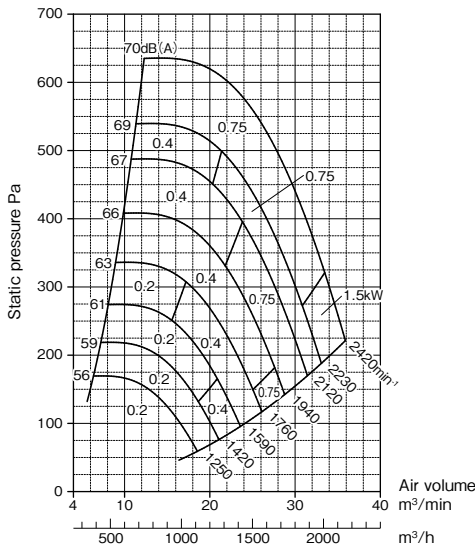

No.1½

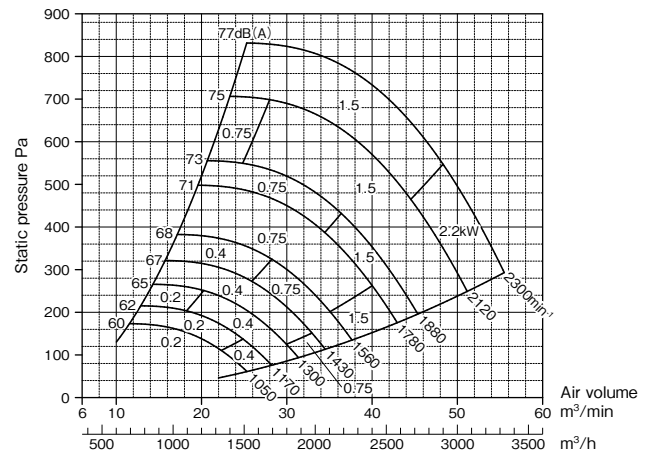

No.1¾

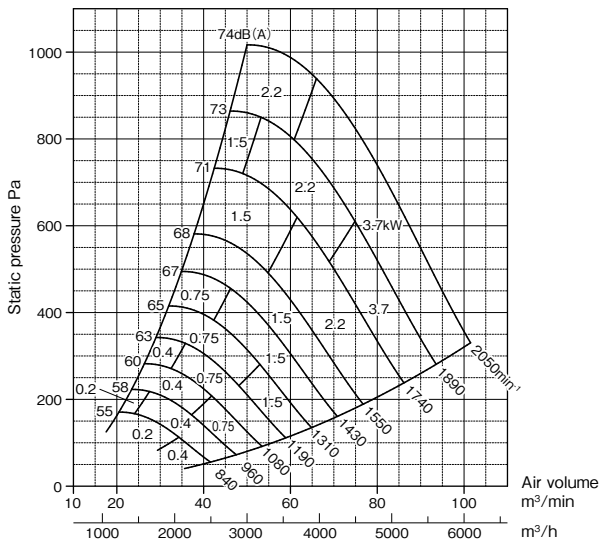

No.2

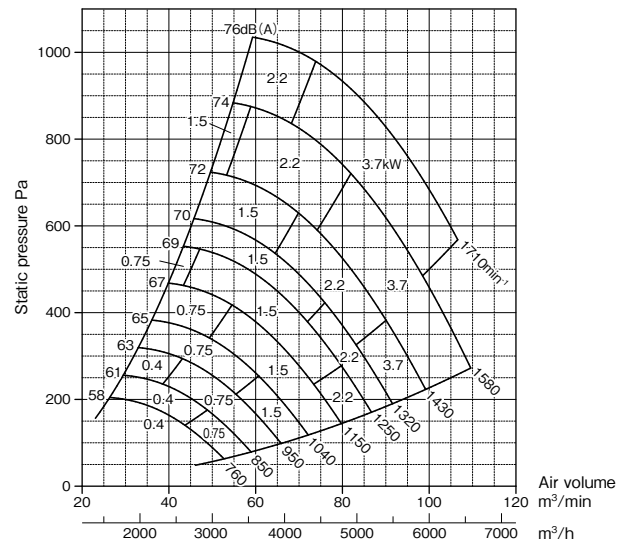

Performance drawing

No.2½

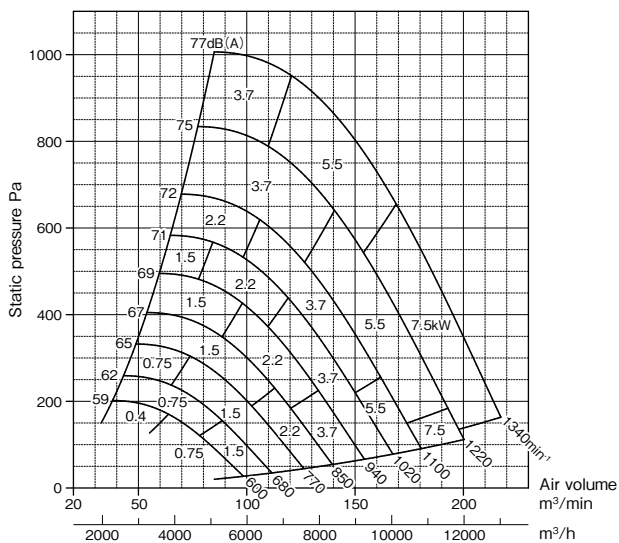

No.3

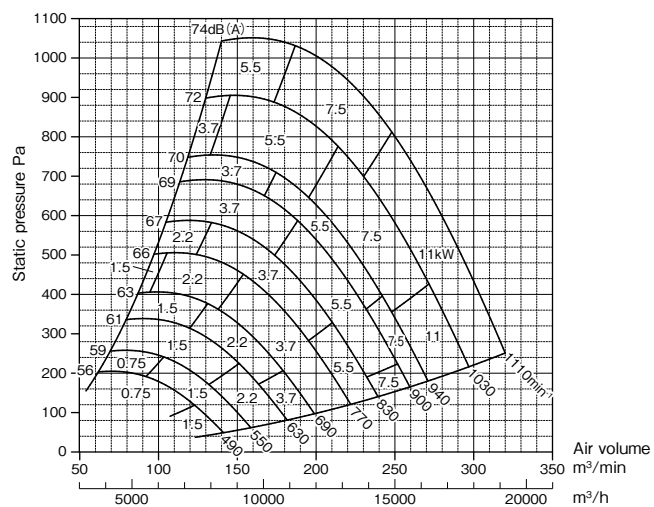

* For No. 3½ or higher, performance drawings for standard materials and for gas contact parts made of SUS are identical.

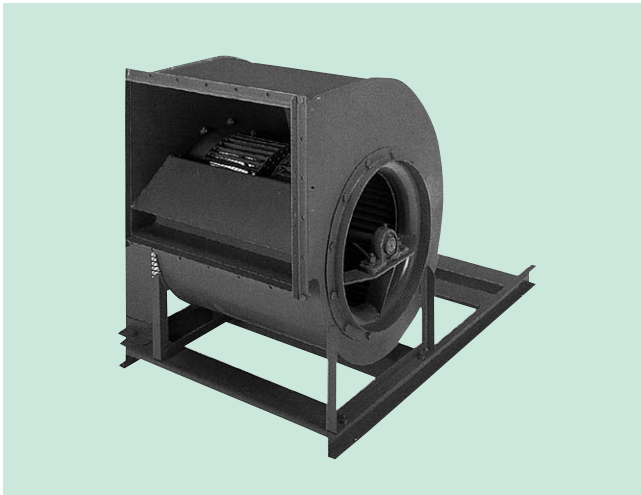

* Keep in mind that the above shows a typical example, part of which may differ from actual devices.

Performance drawing

No.2

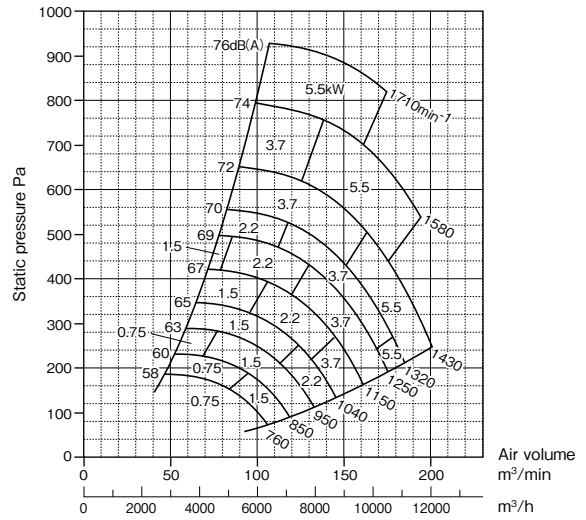

No.2½

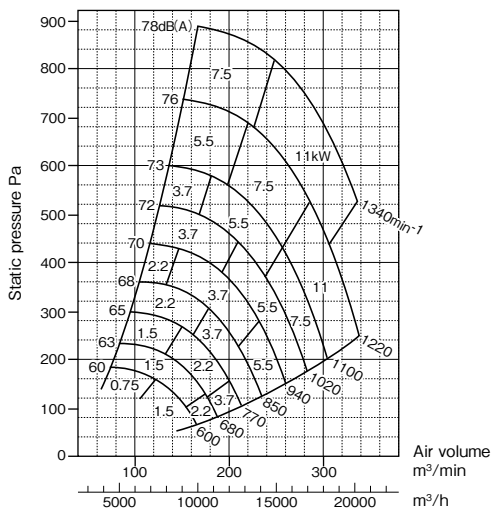

No.3

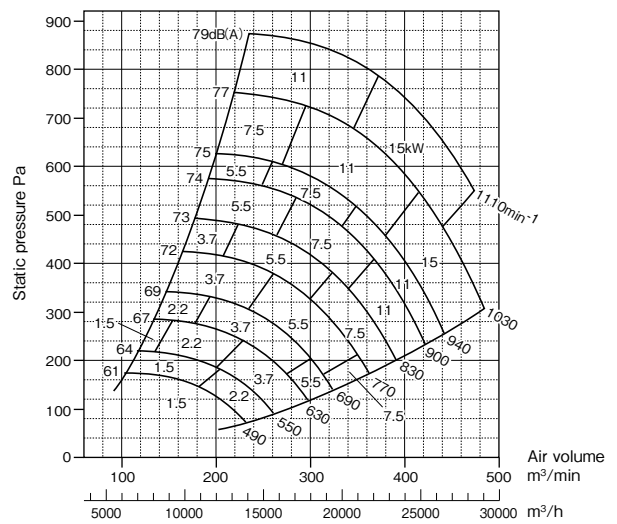

No.3½

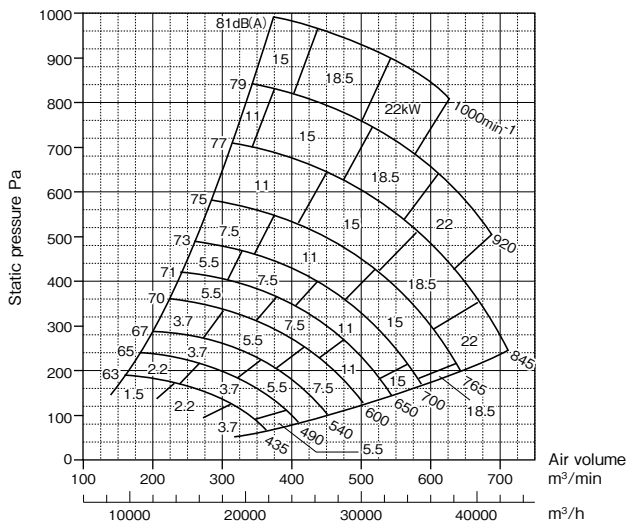

No.4

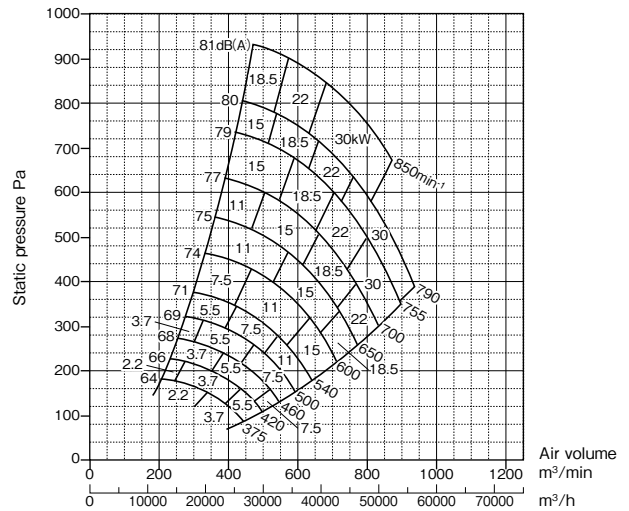

Performance drawing

*In performance drawings, rotation speeds in black and in green correspond to 4P and 6P, respectively, for the number of poles.

No.4½

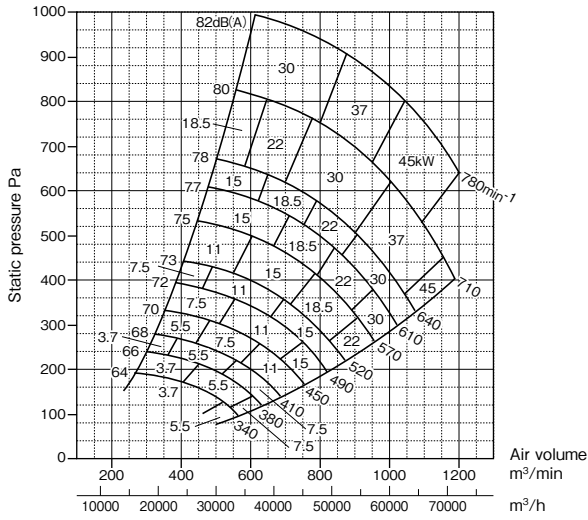

No.5

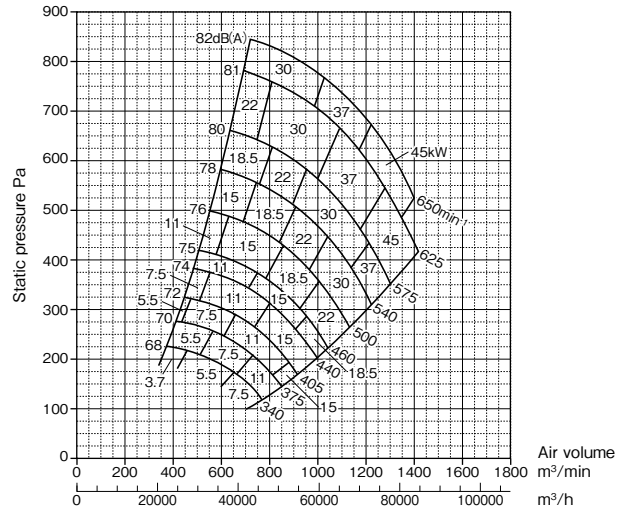

No.5½

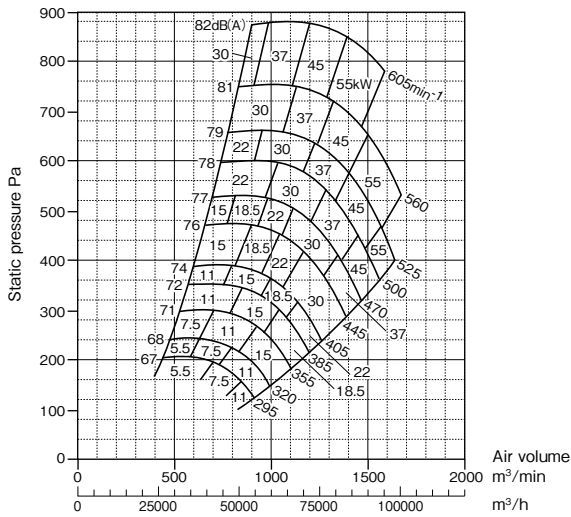

No.6

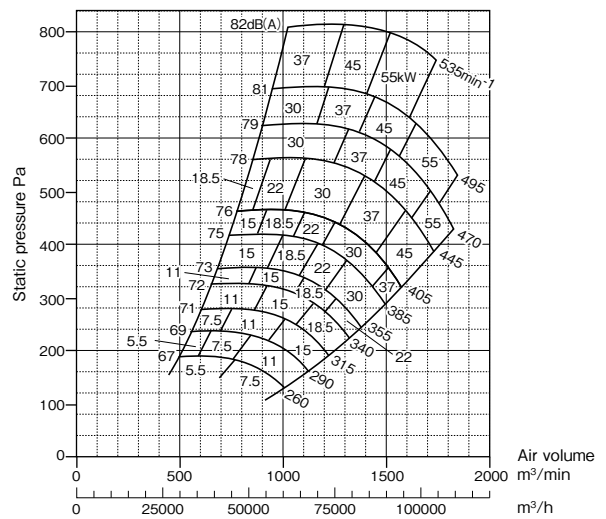

No.6½

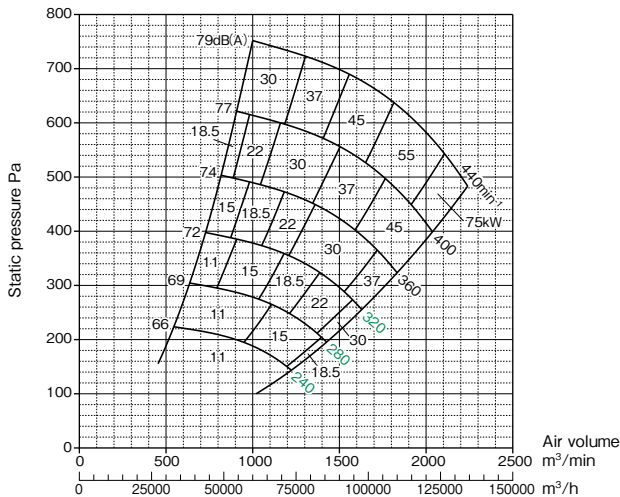

No.7

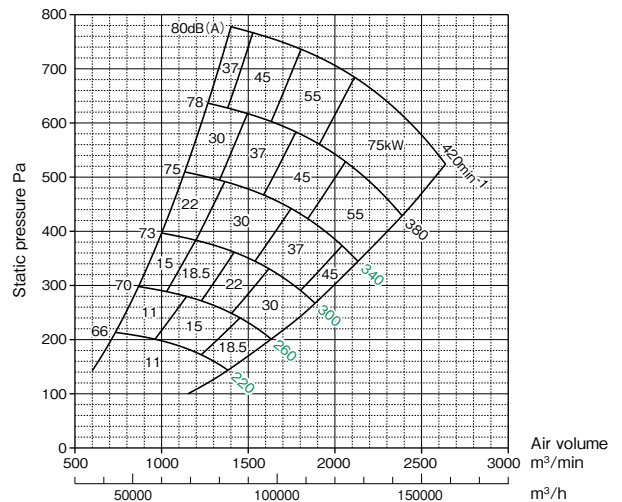

Performance drawing

*In performance drawings, rotation speeds in black and in green correspond to 4P and 6P, respectively, for the number of poles.

No.8

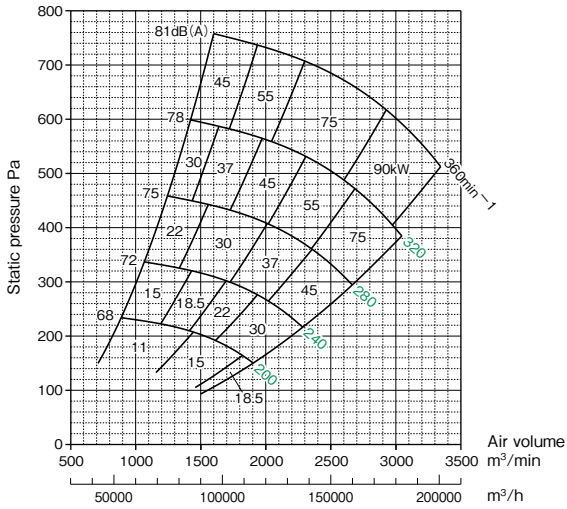

No.9

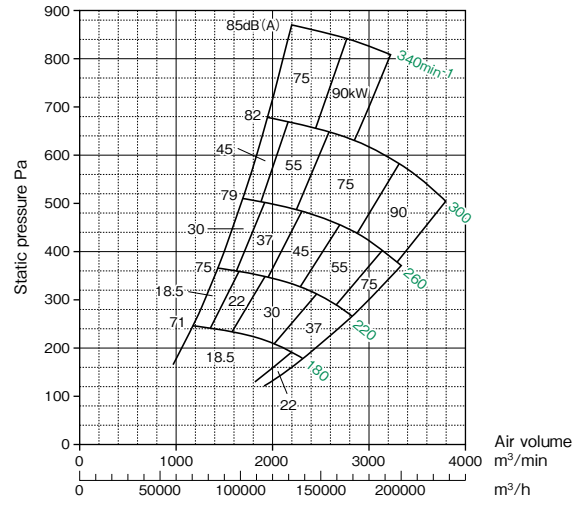

No.10

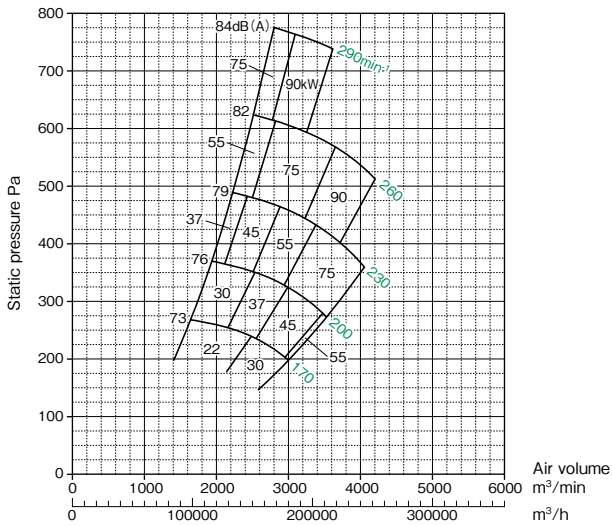

Assembly drawing

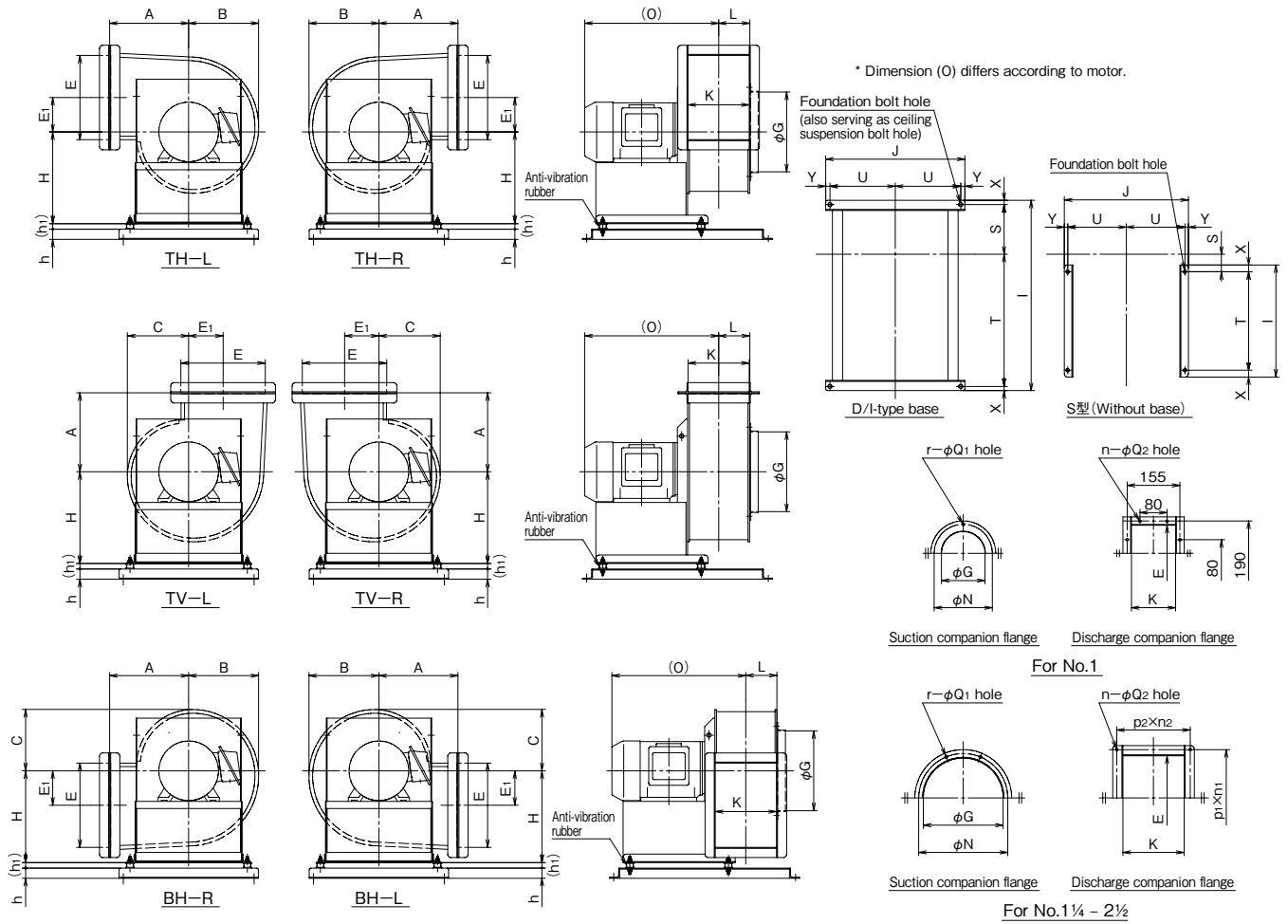

Size table

(Unit: mm)

No.	Main body							Suction companion flange					Discharge companion flange					
	A	B	C	E ₁	H	L	O	φG	φN	r × φQ ₁	Shaped steel size	E	K	p ₁ × n ₁	p ₂ × n ₂	n × φQ ₂	Shaped steel size	
1	155	140	123	67.5	200	66	267	128	171	4-φ8	L30×25×1	165	130	—	—	8-φ7	L25×25×2.3	
1¼	233	206	181	101	270	92	356	235	262	8-φ8	L25×25×2.3	248	180	95×3	72×3	12-φ7	L30×30×3	
1½	233	206	181	101	270	92	394	235	262	8-φ8	L25×25×2.3	248	180	95×3	72×3	12-φ7	L30×30×3	
1¾	290	282	238	162.5	390	112	463	310	350	8-φ10	L30×30×2.3	325	220	90×4	85×3	14-φ10	L30×30×3	
2	290	282	238	162.5	390	112	469	310	350	8-φ10	L30×30×2.3	325	220	90×4	85×3	14-φ10	L30×30×3	
2½	330	351	295	202.5	460	139	556	400	435	8-φ10	L30×30×2.3	405	275	88×5	78×4	18-φ10	L30×30×3	

No.	Base															Approx. mass (not including motor) kg					
	S-type							D/I-type								h	h ₁	Foundation bolt hole			
	I	J	S	T	U	X	Y	I	J	S	T	U	X	Y	S-type			D/I-type	S-type	D/I-type	
1	270	250	26	230	115	20	10	450	295	121	304	135	12.5	12.5	30	16	4-φ10	4-φ12	10	15	
1¼	330	365	51	290	172.5	20	10	560	410	146	389	192.5	12.5	12.5	30	16	4-φ10	4-φ12	20	25	
1½	330	365	51	290	172.5	20	10	560	410	146	389	192.5	12.5	12.5	30	16	4-φ10	4-φ12	20	25	
1¾	400	475	51	360	220	20	17.5	670	547	171	464	248.5	17.5	25	40	18	4-φ12	4-φ12	40	45	
2	400	475	51	360	220	20	17.5	670	547	171	464	248.5	17.5	25	40	18	4-φ12	4-φ12	40	50	
2½	440	565	69	400	265	20	17.5	770	635	214	521	292.5	17.5	25	40	18	4-φ12	4-φ12	60	70	

Internal structure drawing

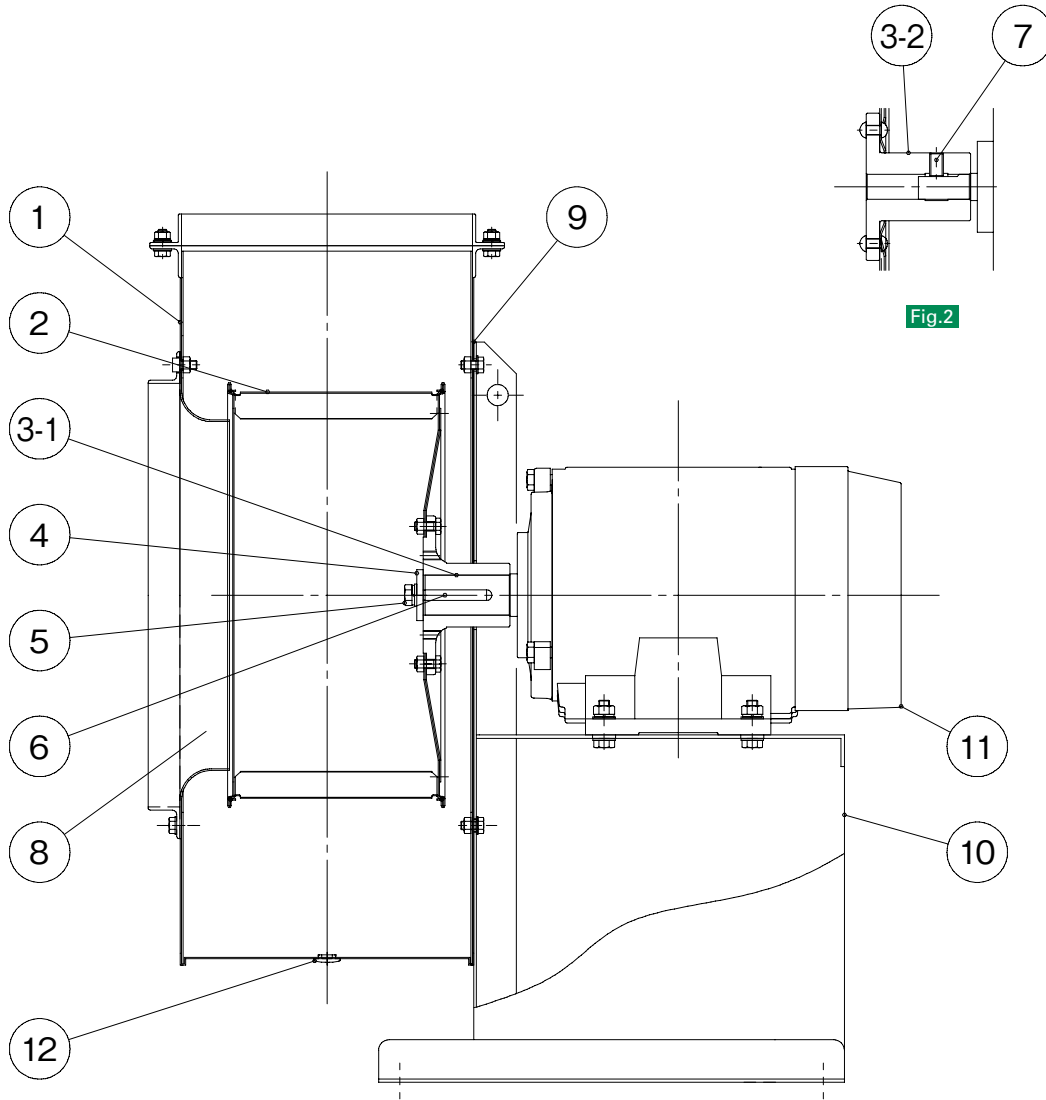

Fig.1

Fig.2

* The method of fixing the impeller is either as shown in Fig. 1 or as shown in Fig. 2 according to motor frame number.

No.	Part name	Qty	Material
1	Casing	1	SPHC · SPCC
2	Impeller	1	SGCC
3-1	Impeller boss	1	FC200
3-2	Impeller boss	1	FC200
4	Impeller retaining washer	1	SS400
5	Impeller retaining bolt	1	SWHC
6	Impeller key	1	S45C

No.	Part name	Qty	Material
7	Impeller fixing bolt	2	SCM435
8	Inlet	1	SPCC
9	Packing	1	Neoprene sponge rubber
10	Motor base	1	SS400 · SPHC
11	Motor	1	—
12	Drain cap	1	EPT

Assembly drawing (No. 1)

Base for TH-R-B, TV-R-B, and BH-L-B types

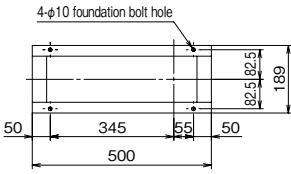

Base for TH-L-B, TV-L-B, and BH-R-B types

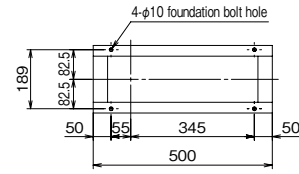

Base for TH-R-D-I, TV-R-D-I, and BH-L-D-I types

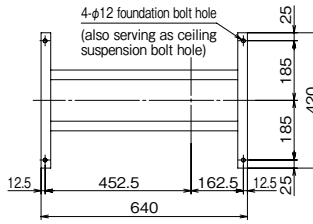

Base for TH-L-D-I, TV-L-D-I, and BH-R-D-I types

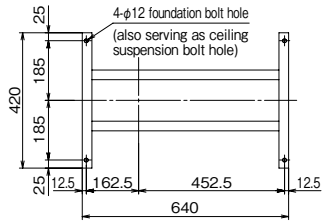

TH-R type

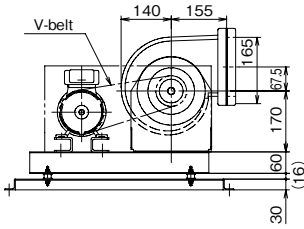

BH-R type

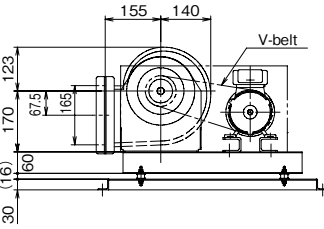

TV-R type

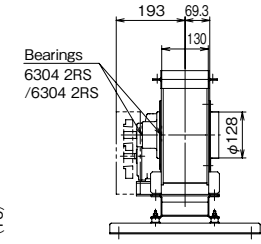
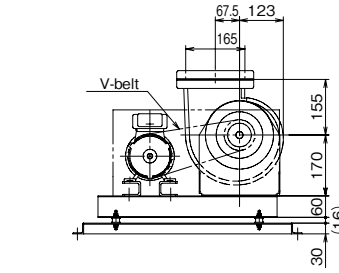

TH-L type

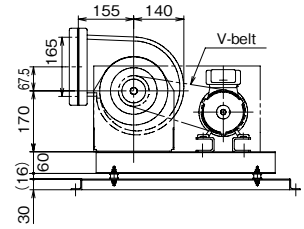

BH-L type

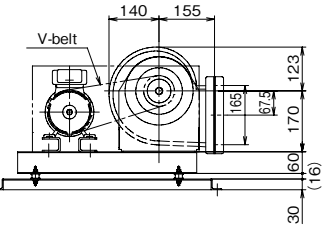

TV-L type

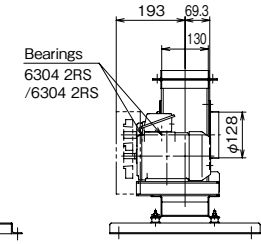
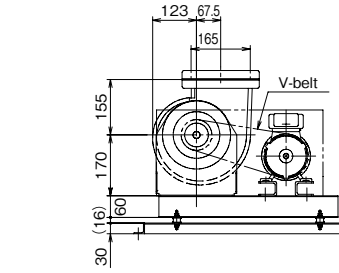

Suction companion flange

L30×25×1

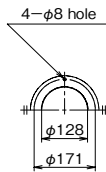

Discharge companion flange

L25×25×2.3

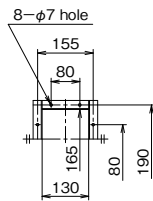

* This drawing shows a view from the V-pulley side.

* This drawing is of a D/I-type.

For a B-type (with common base), assume that there is no anti-vibration base.

Approx. mass (not including motor)

B-type : 17kg

D/I-type : 20kg

* Motor output 0.2 – 0.4kW

* Maximum rotation speed 2550min⁻¹

Assembly drawing (No. 1 ¼ – 2 ½)

Base for TH-R-B, TV-R-B, and BH-L-B types

Base for TH-L-B, TV-L-B, and BH-R-B types

Base for TH-R-D-I, TV-R-D-I, and BH-L-D-I types

Base for TH-L-D-I, TV-L-D-I, and BH-R-D-I types

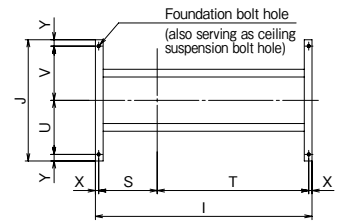
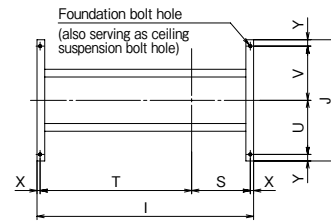
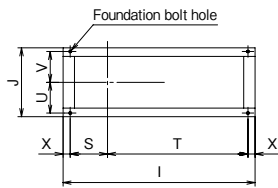
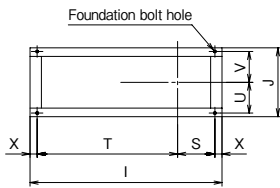

TH-R type

BH-R type

TV-R type

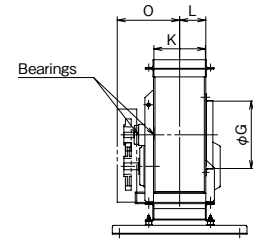
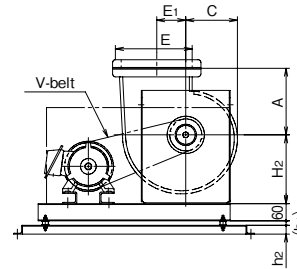
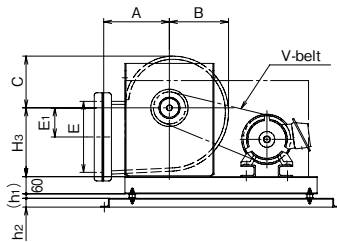
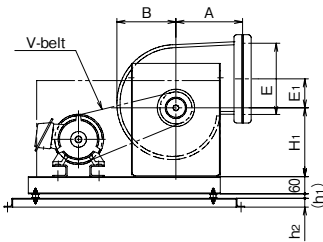

TH-L type

BH-L type

TV-L type

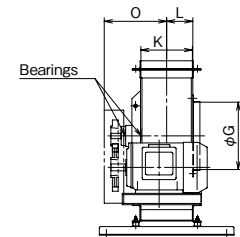
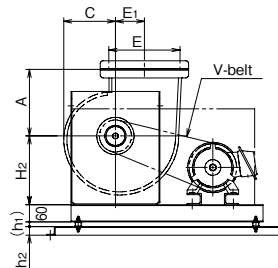
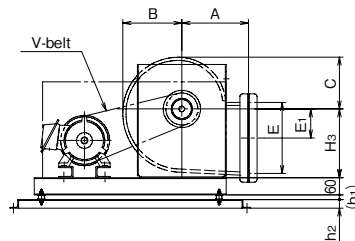
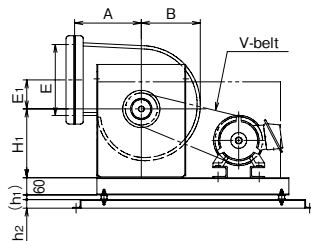

Suction companion flange

Discharge companion flange

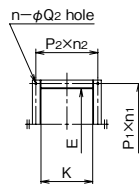
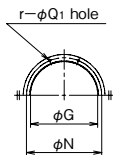

* This drawing shows a view from the V-pulley side.

Size table

(Unit: mm)

Symbol No.	Main body										Bearings		Maximum rotation speed min ⁻¹	Suction companion flange				Discharge companion flange					
	A	B	C	E ₁	H ₁	H ₂	H ₃	L	O	Pulley side	Anti-pulley side	phi G		phi N	r-phi Q ₁	Shaped steel size	E	K	P ₁ xn ₁	P ₂ xn ₂	n-phi Q ₂	Shaped steel size	
1 ¼	232.5	206	181	101	240	240	240	92	218	6304 2RS	6304 2RS	2440	235	262	8-phi 8	L25x25x2.3	248	180	95x3	72x3	12-phi 7	L30x30x3	
1 ½	232.5	206	181	101	240	240	240	92	218	6304 2RS	6304 2RS	2150	235	262	8-phi 8	L25x25x2.3	248	180	95x3	72x3	12-phi 7	L30x30x3	
1 ¾	290	282	238	162.5	340	340	340	112	253	6305 2RS	6305 2RS	1740	310	350	8-phi 10	L30x30x2.3	325	220	90x4	85x3	14-phi 10	L30x30x3	
2	290	282	238	162.5	340	340	340	112	253	6305 2RS	6305 2RS	1580	310	350	8-phi 10	L30x30x2.3	325	220	90x4	85x3	14-phi 10	L30x30x3	
2 ½	330	351	295	202.5	420	420	420	139	285	6305 2RS	6305 2RS	1230	400	435	8-phi 10	L30x30x2.3	405	275	88x5	78x4	18-phi 10	L30x30x3	

Symbol No.	Base																Motor output kW	Approx. mass (not including motor) kg				
	I		J		S		T		U		V		X		Foundation bolt hole							
	B-type	D/I-type	B-type	D/I-type	B-type	D/I-type	B-type	D/I-type	B-type	D/I-type	B-type	D/I-type	B-type	D/I-type	Y	h ₁				h ₂	B-type	D/I-type
1 ¼	670	840	240	470	130	227.5	490	587.5	107.5	210	107.5	210	25	12.5	25	16	30	4-phi 10	4-phi 12	0.2~1.5	30	35
1 ½	670	840	240	470	130	227.5	490	587.5	107.5	210	107.5	210	25	12.5	25	16	30	4-phi 10	4-phi 12	0.2~1.5	30	35
1 ¾	860	1060	280	440	80	267.5	570	757.5	127.5	195	127.5	195	105	17.5	25	16	40	4-phi 12	4-phi 15	0.2~2.2	50	55
2	860	1060	280	440	80	267.5	570	757.5	127.5	195	127.5	195	105	17.5	25	16	40	4-phi 12	4-phi 15	0.4~3.7	55	60
2 ½	1000	1220	335	495	120	322.5	660	862.5	155	222.5	155	222.5	110	17.5	25	18	40	4-phi 12	4-phi 15	0.4~3.7	70	80

This drawing is of a D/I-type. For a B-type (with common base), assume that there is no anti-vibration base.

Internal structure drawing (No. 1 ¼ – 1½)

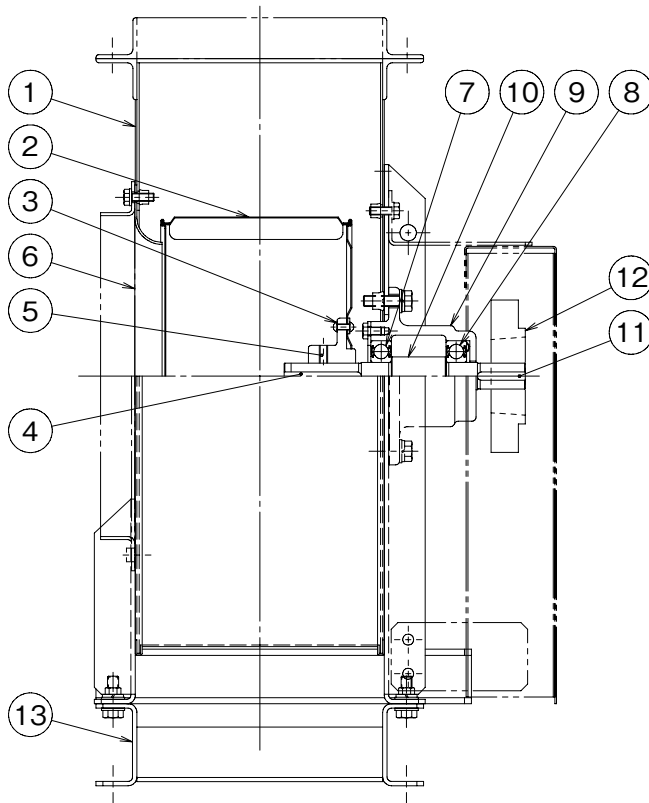

No.	Part name	Qty	Material
1	Casing	1	SPHC · SPCC · SS400
2	Impeller	1	SGCC
3	Impeller hub	1	FC200
4	Impeller key	1	S45C
5	Impeller fixing bolt	2	SCM435
6	Inlet	1	SPCC
7	Ball bearing	1	SUJ
8	Ball bearing	1	SUJ
9	Bearing case	1	FC200
10	Shaft	1	S45C
11	V-pulley key	1	S45C
12	V-pulley	1	FC200
13	Common base	1	SPHC · SS400

* Bearings are 6304 2RS on the pulley side, and 6304 2RS are on the anti-pulley side.

Internal structure drawing (No. 1¾ – 2)

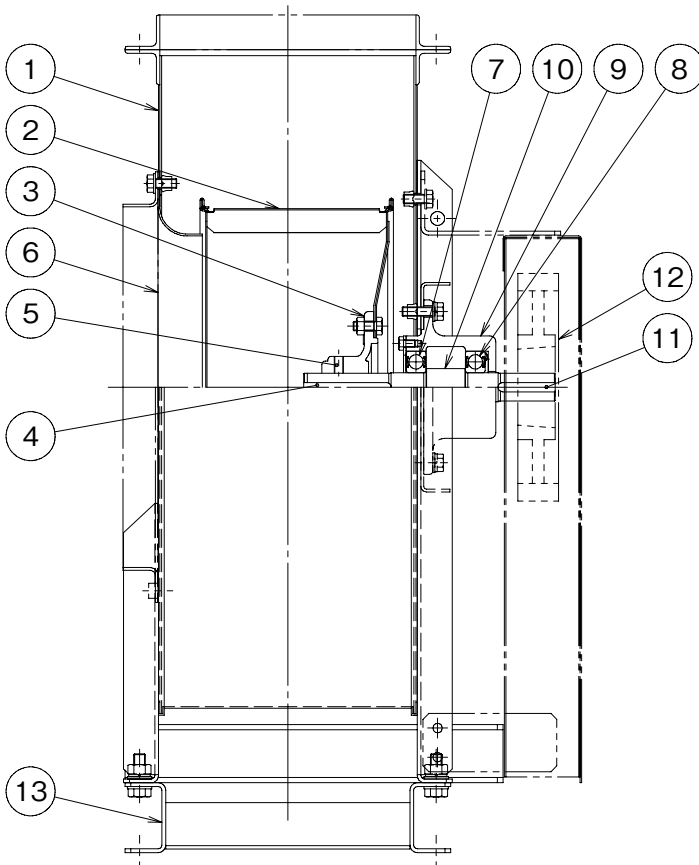

No.	Part name	Qty	Material
1	Casing	1	SPHC · SPCC · SS400
2	Impeller	1	SGCC
3	Impeller hub	1	FC200
4	Impeller key	1	S45C
5	Impeller fixing bolt	2	SCM435
6	Inlet	1	SPHE · SPCC
7	Ball bearing	1	SUJ
8	Ball bearing	1	SUJ
9	Bearing case	1	FC200
10	Shaft	1	S45C
11	V-pulley key	1	S45C
12	V-pulley	1	FC200
13	Common base	1	SPHC · SS400

* Bearings are 6305 2RS on the pulley side, and 6305 2RS are on the anti-pulley side.

Assembly drawing (No. 3 – 4)

Base for TH-R-B, TV-R-B, and BH-L-B types

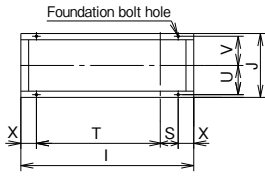

Base for TH-L-B, TV-L-B, and BH-R-B types

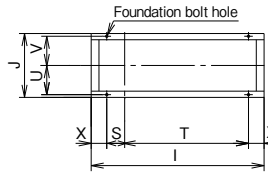

Base for TH-R-D-I, TV-R-D-I, and BH-L-D-I types

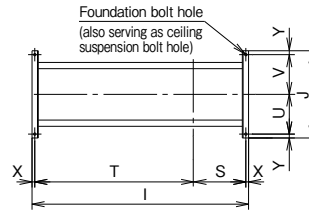

Base for TH-L-D-I, TV-L-D-I, and BH-R-D-I types

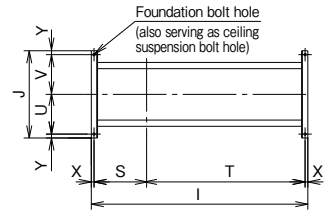

TH-R type

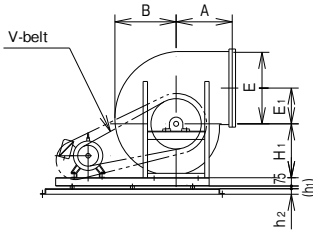

BH-R type

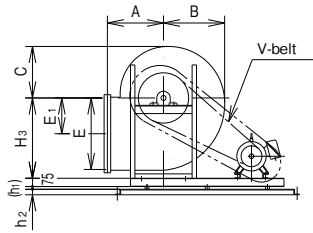

TV-R type

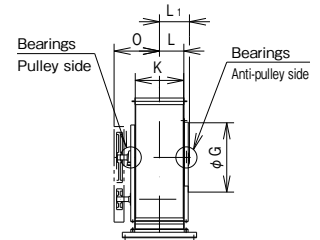
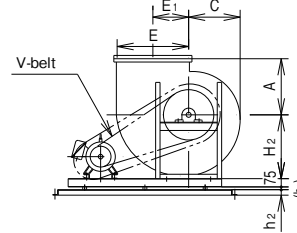

TH-L type

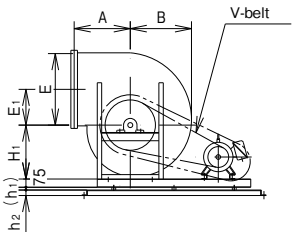

BH-L type

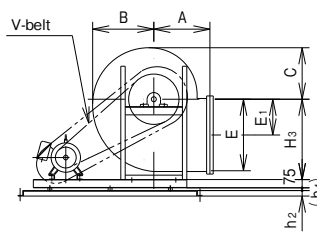

TV-L type

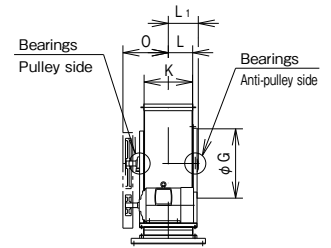
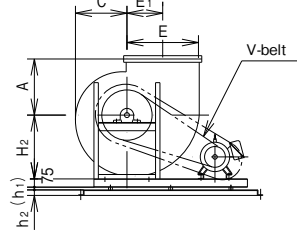

Flanges for No. 3, 3½, and 4

Suction companion flange

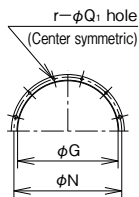

Discharge companion flange

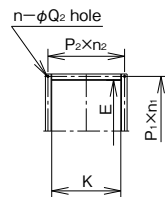

* This drawing shows a view from the V-pulley side.

Size table

(Unit: mm)

Symbol No.	Main body										Bearings		Maximum rotation speed min ⁻¹	Suction companion flange				Discharge companion flange					
	A	B	C	E1	H1	H2	H3	L	L1	O	Pulley side	Anti-pulley side		φG	φN	r-φQ1	Shaped steel size	E	K	P1×n1	P2×n2	n-φQ2	Shaped steel size
3	390	420	355	242.5	380	440	550	167	207	342.5	UCP 308	UCP 205	1110	480	515	12-12	L30×30×3	485	330	174×3	183×2	10-10	L30×30×3
3½	440	490	415	285	440	510	645	194	245	385	UCP 308	UCP 206	920	550	590	12-12	L40×40×3	570	385	151×4	140×3	14-10	L30×30×3
4	510	560	470	325	490	580	730	222	273	412.5	UCP 309	UCP 207	790	630	670	12-12	L40×40×3	650	440	171×4	158×3	14-10	L30×30×3

Symbol No.	Base																Motor output kW	Approx. mass (not including motor) kg				
	I		J		S		T		U		V		X		Y	h1		h2	Foundation bolt hole		B-type	D/I-type
	B-type	D/I-type	B-type	D/I-type	B-type	D/I-type	B-type	D/I-type	B-type	D/I-type	B-type	D/I-type	B-type	D/I-type					B-type	D/I-type		
3	1110	1390	410	560	115	337.5	795	1017.5	187.5	255	187.5	255	100	17.5	25	18	40	4-φ15	4-φ15	0.75~7.5	78	90
3½	1250	1550	465	620	150	380	900	1130	215	285	215	285	100	20	25	18	50	4-φ15	4-φ19	0.75~11	97	116
4	1395	1675	520	675	150	420	945	1215	242.5	312.5	242.5	312.5	150	20	25	18	50	4-φ15	4-φ19	1.5~15	113	134

This drawing is of a D/I-type. For a B-type (with common base), assume that there is no anti-vibration base.

Internal structure drawing (No. 3)

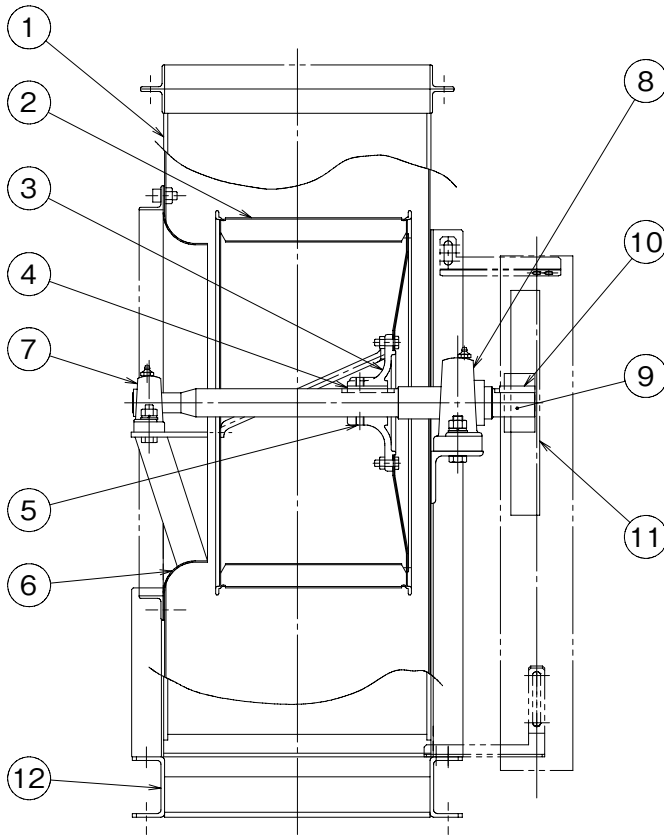

No.	Part name	Qty	Material
1	Casing	1	SPHC · SS400
2	Impeller	1	SGCC · SGHC
3	Impeller hub	1	FC200
4	Impeller key	1	S45C
5	Impeller fixing bolt	2	SCM435
6	Inlet	1	SPCC · SS400
7	Pillow block	1	SUJ
8	Pillow block	1	SUJ
9	Shaft	1	S45C
10	V-pulley key	1	S45C
11	V-pulley	1	FC200
12	Common base	1	SS400

* Bearings are UCP308 on the pulley side, and UCP205 are on the anti-pulley side.

Internal structure drawing (No. 3½)

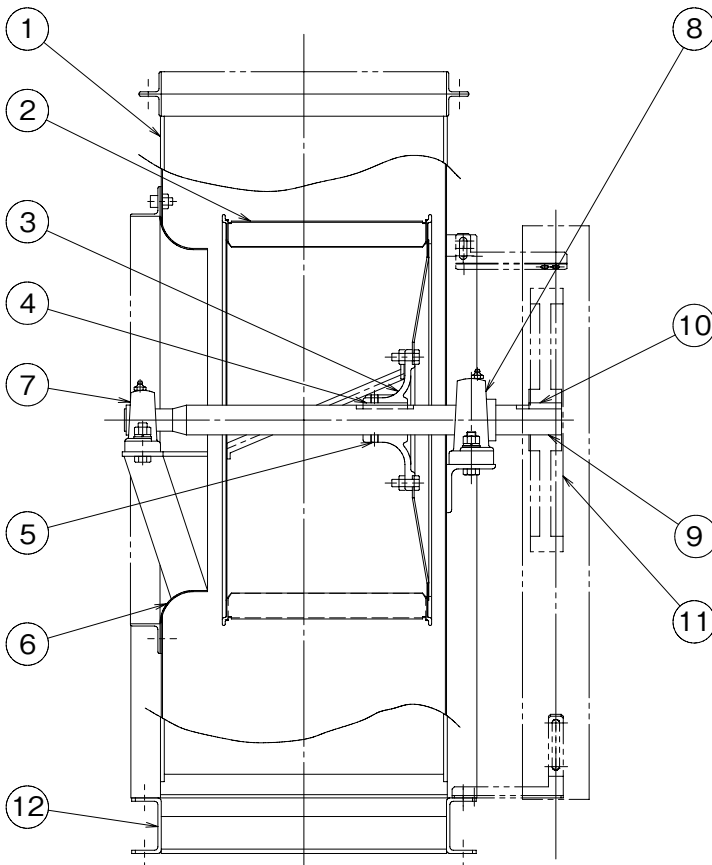

No.	Part name	Qty	Material
1	Casing	1	SPHC · SS400
2	Impeller	1	SGCC · SGHC
3	Impeller hub	1	FC200
4	Impeller key	1	S45C
5	Impeller fixing bolt	2	SCM435
6	Inlet	1	SPCC · SS400
7	Pillow block	1	SUJ
8	Pillow block	1	SUJ
9	Shaft	1	S45C
10	V-pulley key	1	S45C
11	V-pulley	1	FC200
12	Common base	1	SS400

* Bearings are UCP308 on the pulley side, and UCP206 are on the anti-pulley side.

Assembly drawing (No. 4½ – 6)

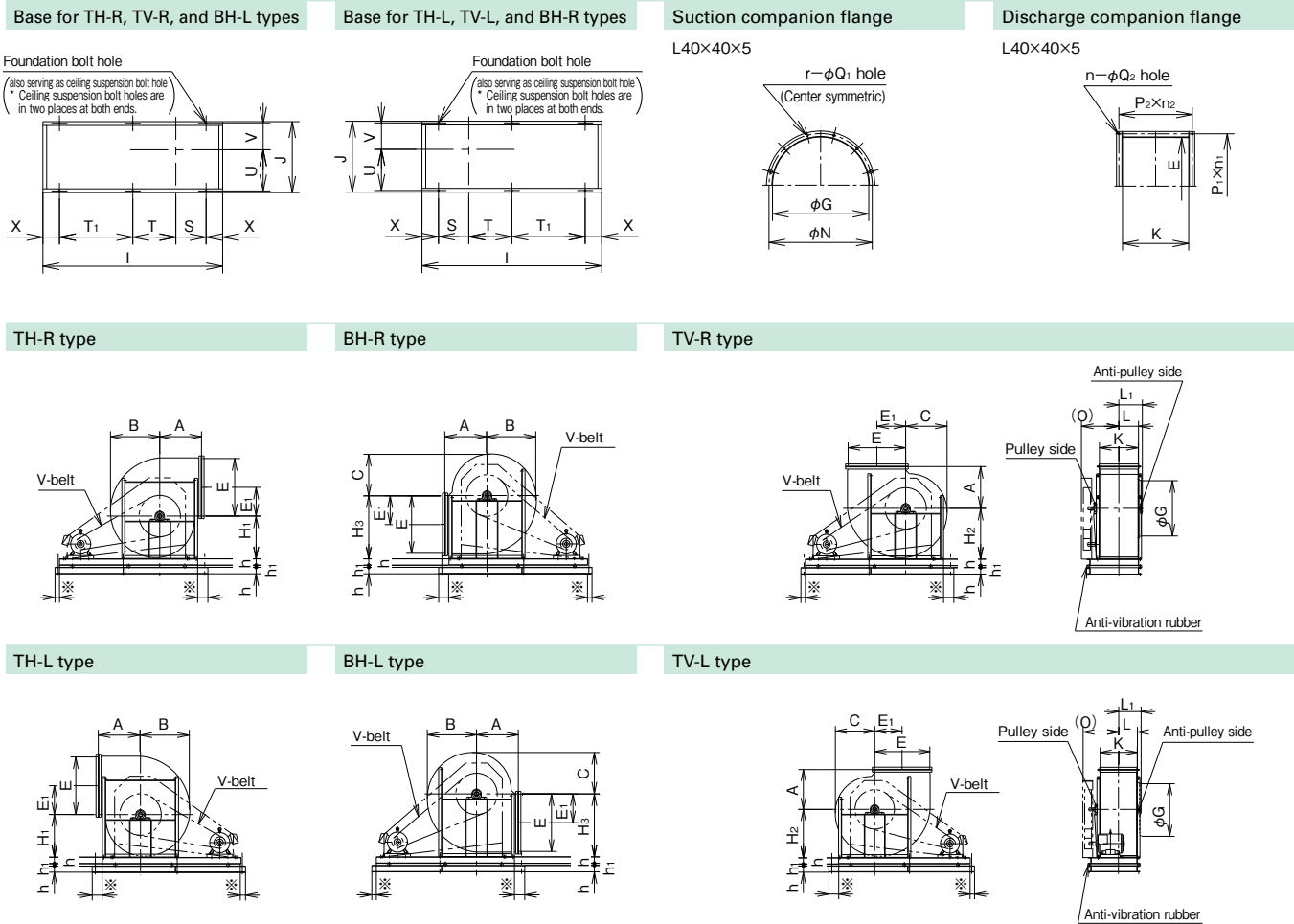

* This drawing shows a view from the V-pulley side.

Size table

(Unit: mm)

Symbol No.	Main body										Bearings		Maximum rotation speed min ⁻¹	Suction companion flange			Discharge companion flange				
	A	B	C	E ₁	H ₁	H ₂	H ₃	L	L ₁	O	Pulley side (motor output kW)	Anti-pulley side		φG	φN	r-φQ ₁	E	K	P ₁ ×n ₁	P ₂ ×n ₂	n-φQ ₂
4½	550	630	530	365	550	650	820	251	303	540	UCP 210(1.5~7.5)	UCP 207	780	710	750	16-12	730	495	97×8	90×6	28-12
											UCP 310(11~22)										
5	590	700	590	407.5	610	720	900	278	341	560	UCP 210(1.5~7.5)	UCP 208	675	780	825	16-15	815	550	86×10	99×6	32-12
											UCP 310(11~22)										
5½	650	770	645	447.5	665	790	980	306	366	585	UCP 212(2.2~15)	UCP 209	615	860	905	16-15	895	605	94×10	93×7	34-12
											UCP 312(18.5~30)										
6	700	835	705	487.5	730	860	1060	333	393	615	UCP 212(2.2~15)	UCP 209	535	935	980	16-15	975	660	85×12	88×8	40-15
											UCP 312(18.5~30)										

Symbol No.	Installation method	Base											Foundation bolt hole	Ceiling suspension bolt hole	Motor output kW	Approx. mass (not including motor) kg			
		I	J	S	T	T ₁	U	V	X	Y	h	h ₁				B/E (without anti-vibration)	D/I (with anti-vibration)		
4½	D/B-type	1770	750	320	390	710	435	280	175	17.5	75	18	6-φ15	—	1.5~15	310	340		
		1900			455	775									18.5~22	345	380		
	I/E-type	1990	750	595	1295	—	435	280	50	17.5	75	18			4-φ19	4-φ19	1.5~15	325	350
		2120			1425												18.5~22	350	385
5	D/B-type	1880	800	360	405	765	455	305	175	20	100	27	6-φ19	—			2.2~15	390	430
		2000			465	825											18.5~22	440	480
5½	D/B-type	2050	850	390	435	825	477.5	332.5	200	20	100	27			6-φ19	—	2.2~18.5	470	510
		2150			485	875											22~30	525	570
6	D/B-type	2150	910	440	435	875	510	360	200	20	100	27	6-φ19	—			2.2~18.5	550	600
		2300			510	950											22~30	600	650

This drawing is of an I-type. For a B/E-type, assume that there is no anti-vibration base. In the case of a floor type, the mount is shortened at the parts marked with *.

Assembly drawing (No. 6½ – 10)

Base for TH-R, TV-R, and BH-L types

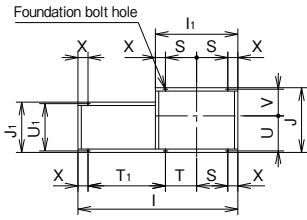

Base for TH-L, TV-L, and BH-R types

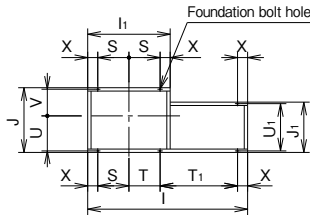

Suction companion flange

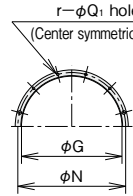

Discharge companion flange

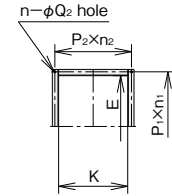

TH-R type

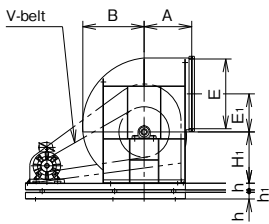

BH-R type

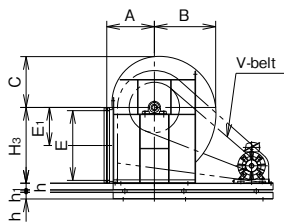

TV-R type

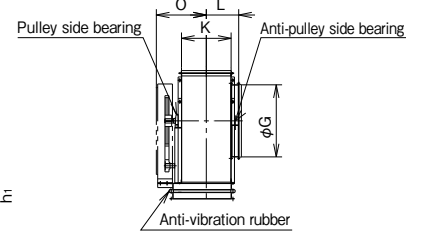
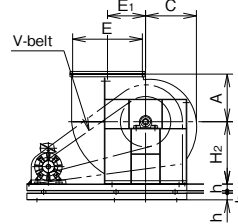

TH-L type

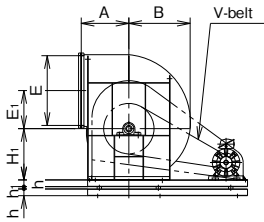

BH-L type

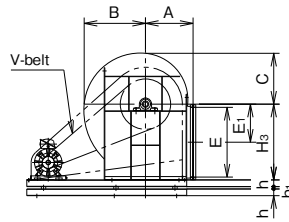

TV-L type

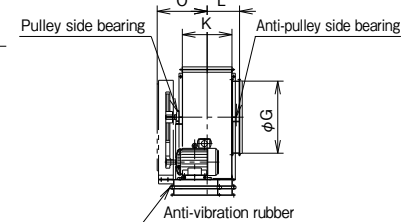
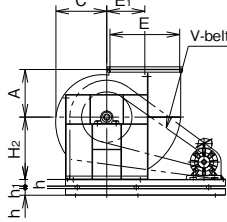

* This drawing shows a view from the V-pulley side.

Size table

(Unit: mm)

Symbol No.	Main body										Bearings		Maximum rotation speed min ⁻¹	Suction companion flange			Discharge companion flange				
	A	B	C	E ₁	H ₁	H ₂	H ₃	L	O	Pulley side	Anti-pulley side	φG		φN	r-φQ	E	K	p ₁ xn ₁	p ₂ xn ₂	n-φQ	Shaped steel size
6½	710	919	762	568	765	930	1130	483	745	UCP 314	UCP 210	460	1075	1120	20-15	1040	740	181x6	196x4	20-15	L40x40x3
7	760	989	820	613	835	990	1230	513	785	UCP 315	UCP 211	420	1160	1205	20-15	1120	800	194x6	169x5	22-15	L40x40x3
8	865	1107	922	673	930	1125	1385	578	850	UCP 317	UCP 212	380	1320	1380	24-19	1270	910	190x7	194x5	24-19	L50x50x4
9	970	1255	1040	780	1045	1260	1550	653	945	UCP 320	UCP 213	340	1475	1535	24-19	1425	1020	186x8	180x6	28-19	L50x50x4
10	1080	1389	1159	838	1175	1420	1730	718	1040	UCP 322	UCP 216	300	1665	1725	32-19	1610	1150	186x9	173x7	32-19	L50x50x4

Symbol No.	Base													Foundation bolt hole	Motor output kW	Approx. mass (not including motor) kg	
	I	I ₁	J	J ₁	S	T	T ₁	U	U ₁	V	X	h	h ₁			B (without anti-vibration)	D (with anti-vibration)
6½	2385	1230	965	750	465	465	1155	522.5	705	397.5	150	100	34	6-φ19	2.2~37	780	850
7	2530	1320	1050	750	510	510	1210	555	690	435	150	125	45	6-φ24	3.7~45	910	1020
8	2700	1480	1170	750	540	540	1220	620	690	490	200	125	45	6-φ24	5.5~75	1180	1300
9	2900	1650	1310	850	575	575	1250	700	780	540	250	150	55	6-φ24	5.5~75	1770	2000
10	3050	1830	1460	950	665	665	1220	775	880	615	250	150	55	6-φ28	7.5~75	2290	2540

This drawing is of an D-type. For a B-type, assume that there is no anti-vibration base.
No. 10 has vertical split casing.

Internal structure drawing (No. 4½ - 6)

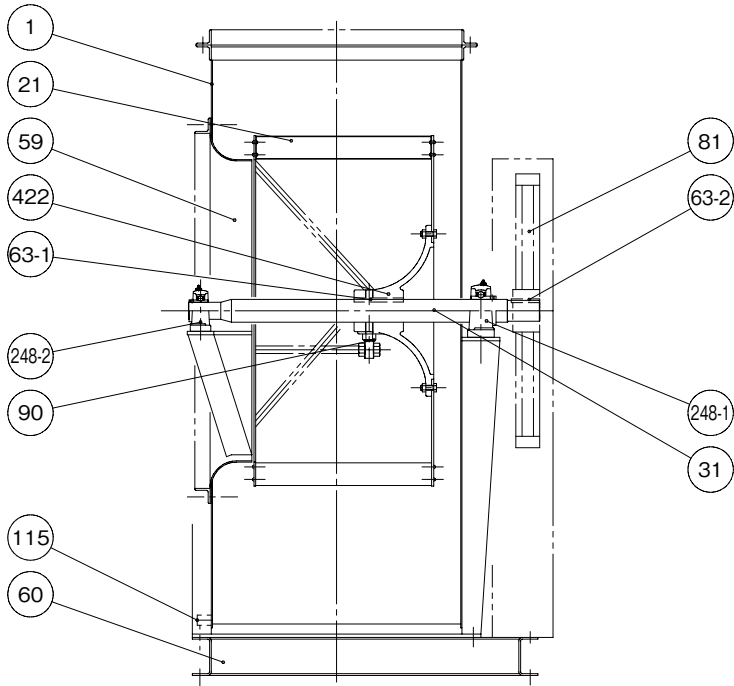

No.	Part name	Qty	Material
1	Casing	1	SPHC
21	Impeller	1	SPHC
422	Impeller hub	1	FC200
90	Impeller fixing bolt	2	SS400
63-1	Impeller key	1	S45C
59	Inlet	1	SS400 · SPHC
31	Shaft	1	S45C
81	V-pulley	1	FC200
63-2	V-pulley key	1	S45C
60	Common base	1	SS400
115	Drain	1	SS400

No.	Part name	Qty	Material	No.4½	No.5	No.5½	No.6
248-1	Pillow block	1	SUJ	UCP210 (1.5~7.5kW)	UCP210 (1.5~7.5kW)	UCP212 (2.2~15kW)	UCP212 (2.2~15kW)
248-1	Pillow block	1	SUJ	UCP310 (11~22kW)	UCP310 (11~22kW)	UCP312 (18.5~30kW)	UCP312 (18.5~30kW)
248-2	Pillow block	1	SUJ	UCP207	UCP208	UCP209	UCP209

Internal structure drawing (No. 6½ - 8)

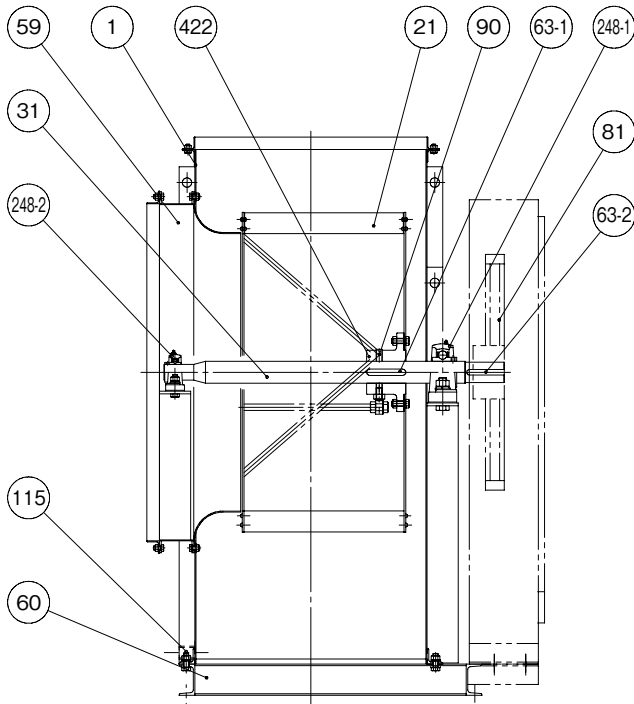

No.	Part name	Qty	Material
1	Casing	1	SS400 · SPHC
21	Impeller	1	SS400 · SEHC
422	Impeller hub	1	FC200
90	Impeller fixing bolt	2	SWCH
63-1	Impeller key	1	S45C
59	Inlet	1	SS400 · SPHC
31	Shaft	1	S45C
81	V-pulley	1	FC200
63-2	V-pulley key	1	S45C
60	Common base	1	SS400
115	Drain	1	SS400

No.	Part name	Qty	Material	No.6½	No.7	No.8	No.9	No.10
248-1	Pillow block	1	SUJ	UCP314	UCP315	UCP317	UCP320	UCP322
248-2	Pillow block	1	SUJ	UCP210	UCP211	UCP212	UCP213	UCP216

Assembly drawing (No. 1)

Base for TH-R-B, TV-R-B, and BH-L-B types

Base for TH-L-B, TV-L-B, and BH-R-B types

Base for TH-R-D, TV-R-D, and BH-L-D types

Base for TH-L-D, TV-L-D, and BH-R-D types

Suction companion flange

L25×25×3.2

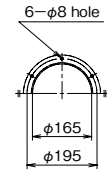
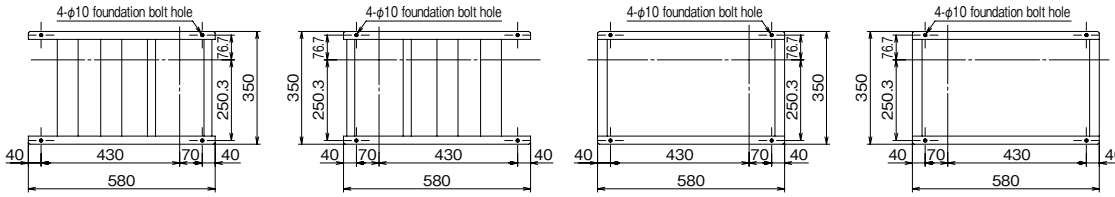

Base for TH-R-I, TV-R-I, and BH-L-I types

Base for TH-L-I, TV-L-I, and BH-R-I types

Discharge companion flange

L25×25×2.3

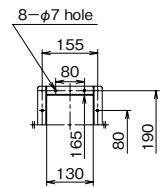
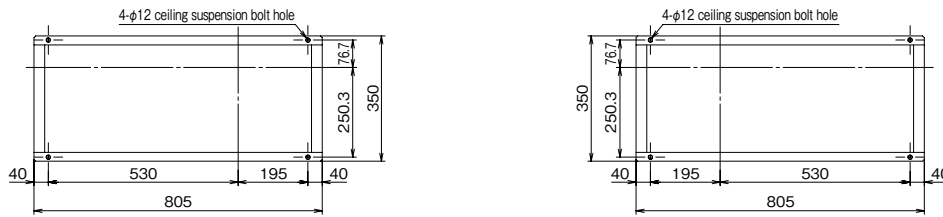

TH-R type

BH-R type

TV-R type

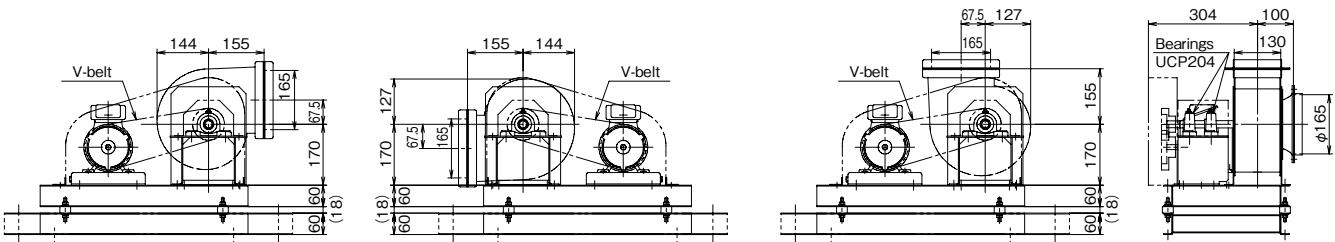

TH-L type

BH-L type

TV-L type

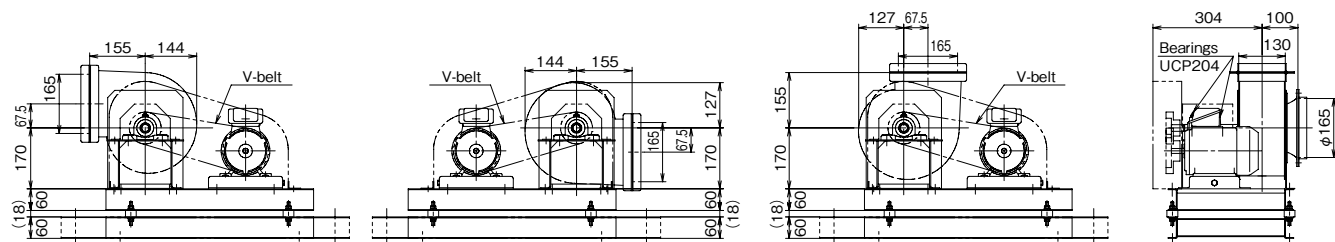

* This drawing shows a view from the V-pulley side.

* D-type (floor, anti-vibration type) is drawn in solid lines.

Assume that B-type (with common base) is up to the common base.

I-type (ceiling-suspended, anti-vibration mount type) is drawn in chain double-dashed lines.

* Motor output 0.2 – 0.4kW

* Maximum rotation speed 2550min⁻¹

Approx. mass (not including motor)

B-type : 25kg

D-type : 30kg

I-type : 30kg

Assembly drawing (No. 1 ¼ - 3)

Base for TH-R-B, TV-R-B, and BH-L-B types

Base for TH-L-B, TV-L-B, and BH-R-B types

Base for TH-R-D, TV-R-D, and BH-L-D types

Base for TH-L-D, TV-L-D, and BH-R-D types

Suction companion flange

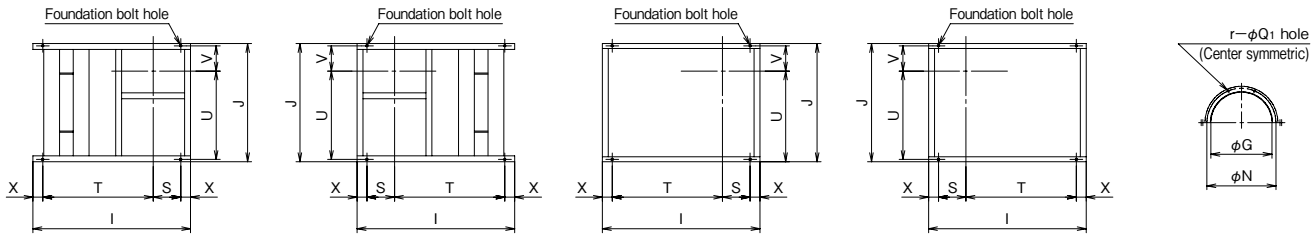

Base for TH-R-I, TV-R-I, and BH-L-I types

Base for TH-L-I, TV-L-I, and BH-R-I types

Discharge companion flange

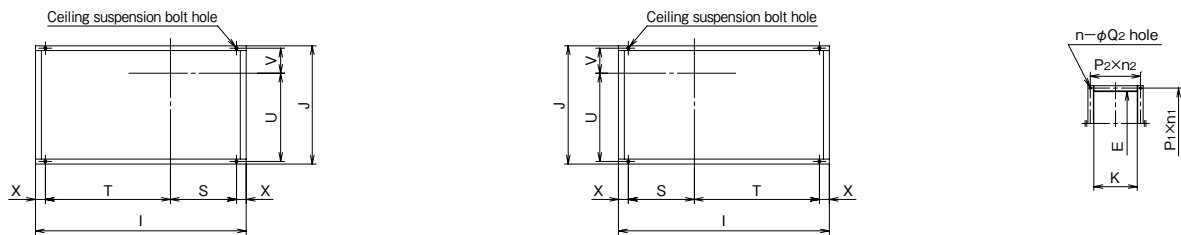

TH-R type

BH-R type

TV-R type

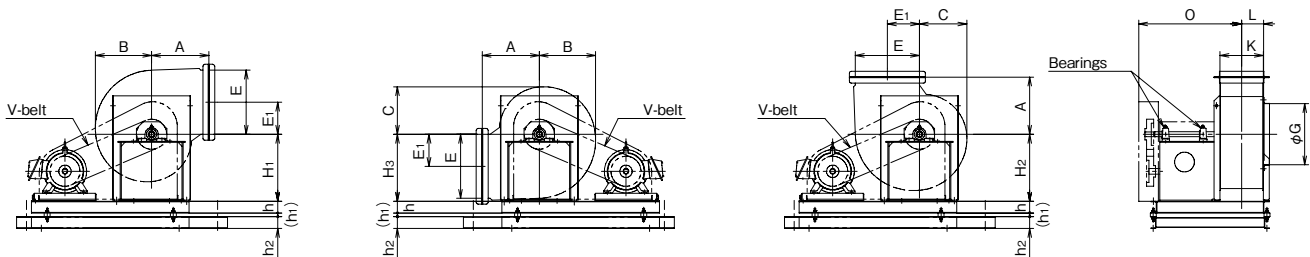

TH-L type

BH-L type

TV-L type

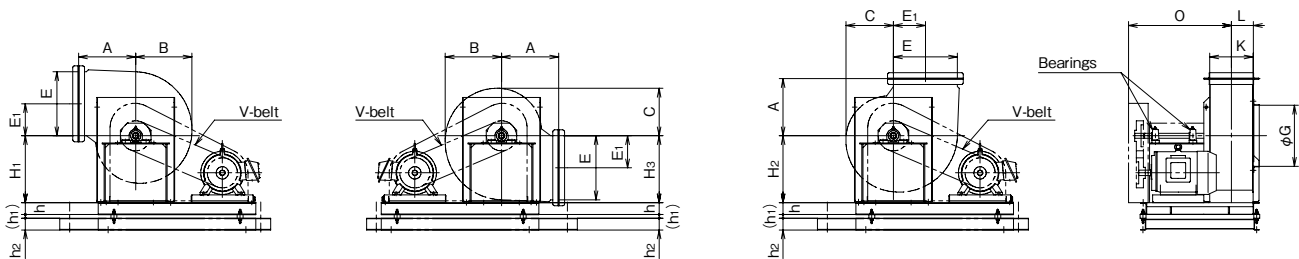

* This drawing shows a view from the V-pulley side.

Size table

(Unit: mm)

Symbol No.	Main body										Bearings	Maximum rotation speed min ⁻¹	Suction companion flange				Discharge companion flange				
	A	B	C	E ₁	H ₁	H ₂	H ₃	L	O	φG			φN	r-φQ1	Shaped steel size	E	K	P ₁ xn ₁	P ₂ xn ₂	n-φQ ₂	Shaped steel size
1 ¼	233	211	185	101	240	240	240	92	423	UCP204	2440	235	262	8-φ8	L25×25×2.3	248	180	95×3	72×3	12-φ7	L30×30×3
1 ½	233	211	185	101	240	240	240	92	423	UCP204	2360	235	262	8-φ8	L25×25×2.3	248	180	95×3	72×3	12-φ7	L30×30×3
1 ¾	290	286	241	162.5	340	340	340	112	522	UCP205	2070	310	350	8-φ10	L30×30×2.3	325	220	90×4	85×3	14-φ10	L30×30×3
2	290	286	241	162.5	340	340	340	112	522	UCP205	1730	310	350	8-φ10	L30×30×2.3	325	220	90×4	85×3	14-φ10	L30×30×3
2 ½	330	354	298	202.5	420	420	420	139	625	UCP306	1340	400	435	8-φ10	L30×30×2.3	405	275	88×5	78×4	18-φ10	L30×30×3
3	390	423	357	242.5	380	440	550	167	697	UCP307	1110	480	515	12-φ12	L30×30×3	485	330	87×6	73×5	22-φ12	L30×30×3

Symbol No.	Base																Motor output kW	Approx. mass (not including motor) kg						
	I	J	S	T	U	V	X	h	h1	h2	B/D-type foundation bolt hole	I-type ceiling suspension bolt hole	B-type	D-type	I-type									
1 ¼	680	910	500	90	275	490	555	368.5	368.5	108.5	108.5	50	40	60	60	18	60	60	4-φ10	4-φ12	0.2~1.5	45	50	50
1 ½	680	910	500	90	275	490	555	368.5	368.5	108.5	108.5	50	40	60	60	18	60	60	4-φ10	4-φ12	0.2~2.2	45	50	55
1 ¾	800	1070	600	140	335	560	635	448.5	447.5	128.5	127.5	50	50	60	60	18	60	65	4-φ12	4-φ15	0.2~3.7	80	85	90
2	800	1070	600	140	335	560	635	448.5	447.5	128.5	127.5	50	50	60	60	18	60	65	4-φ12	4-φ15	0.4~3.7	80	85	90
2 ½	850	1120	730	130	375	520	645	550	550	155	155	100	50	65	65	18	65	65	4-φ12	4-φ15	0.4~3.7	115	125	125
	960	1230				630	755														730	855	617.5	617.5
3	980	1250	840	200	445	580	705	617.5	617.5	187.5	187.5	100	50	65	65	34	65	75	4-φ15	4-φ19	0.75~5.5	160	180	180
	1130	1400				730	855														730	855	617.5	617.5

* D-type (floor, anti-vibration type) is drawn in solid lines. Assume that B-type (with common base) is up to the common base. I-type (ceiling-suspended, anti-vibration mount type) is drawn in chain double-dashed lines.

Internal structure drawing (No. 1¾ - 2½: Casing with swaging structure)

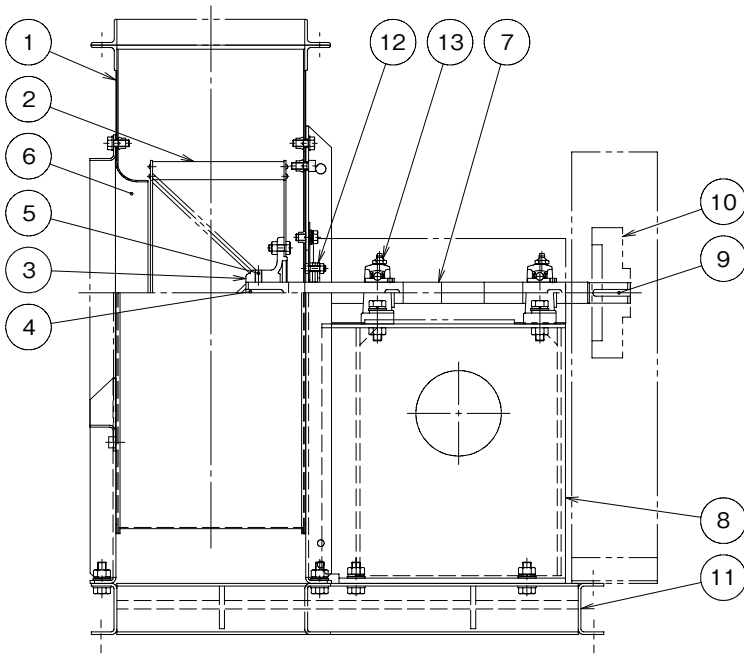

No.	Part name	Qty	Material
1	Casing	1	SPHC · SPCC · SS400
2	Impeller	1	SPHC · SECC · SS400
3	Impeller hub	1	FC200
4	Impeller key	1	S45C
5	Impeller fixing bolt	2	SCM435
6	Inlet	1	SPHE · SPCC
7	Shaft	1	S45C
8	Bearing stand	1	SPHC
9	V-pulley key	1	S45C
10	V-pulley	1	FC200
11	Common base	1	SPHC · SS400
12	Shaft seal	1	

No.	Part name	Qty	Material	No.1~1½	No.1¾ · 2	No.2½	No.3
13	Pillow block	2	SUJ	UCP204	UCP205	UCP306	UCP307

* No. 12 shaft seal is a special accessory.

Internal structure drawing (No. 1¾ - 2½: Casing with welding structure)

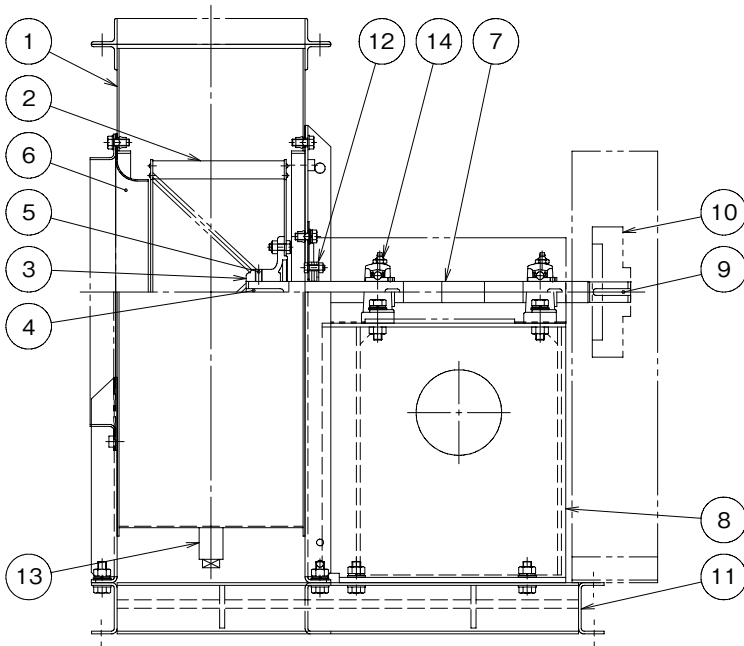

No.	Part name	Qty	Material
1	Casing	1	SPHC · SPCC · SS400
2	Impeller	1	SPHC · SECC · SS400
3	Impeller hub	1	FC200
4	Impeller key	1	S45C
5	Impeller fixing bolt	2	SCM435
6	Inlet	1	SPHE · SPCC
7	Shaft	1	S45C
8	Bearing stand	1	SPHC
9	V-pulley key	1	S45C
10	V-pulley	1	FC200
11	Common base	1	SPHC · SS400
12	Shaft seal	1	
13	Drain	1	SS400

No.	Part name	Qty	Material	No.1~1½	No.1¾ · 2	No.2½	No.3
14	Pillow block	2	SUJ	UCP204	UCP205	UCP306	UCP307

* No. 12 shaft seal is a special accessory.

Assembly drawing (No. 3½ - 4)

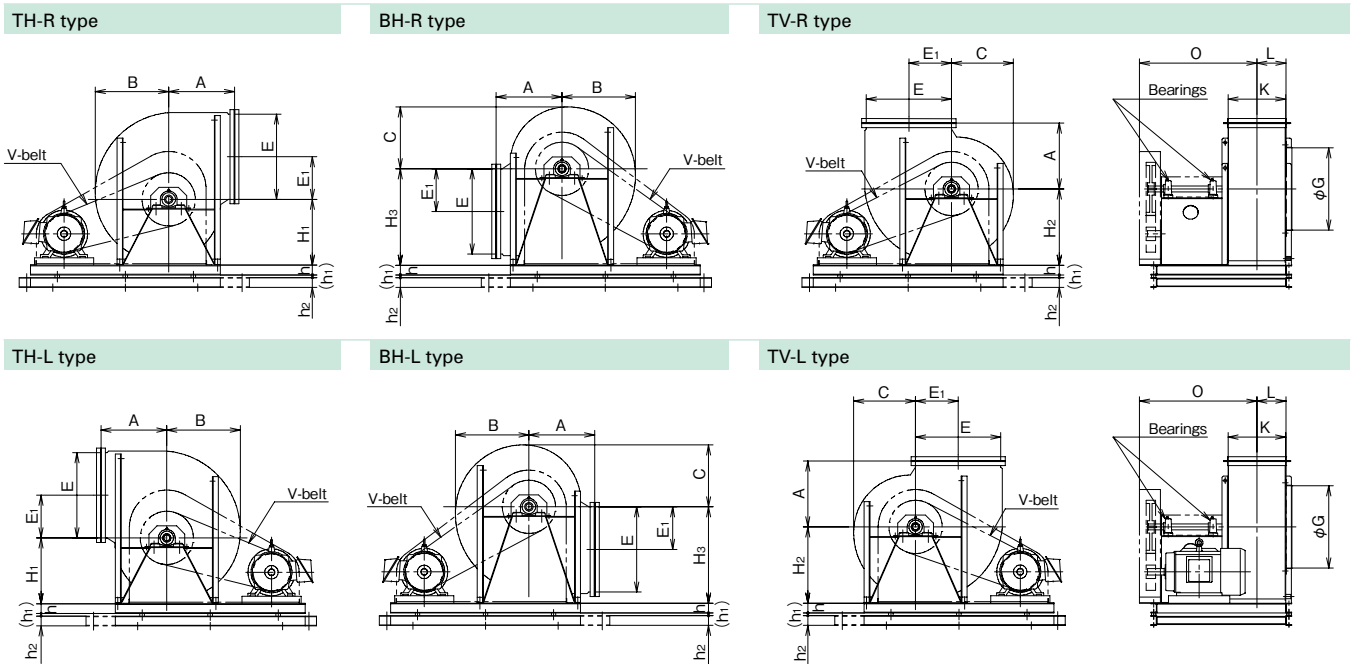
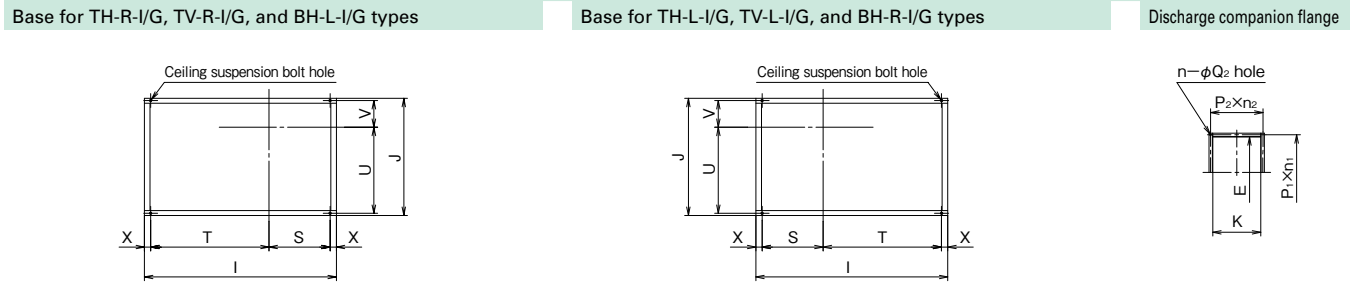
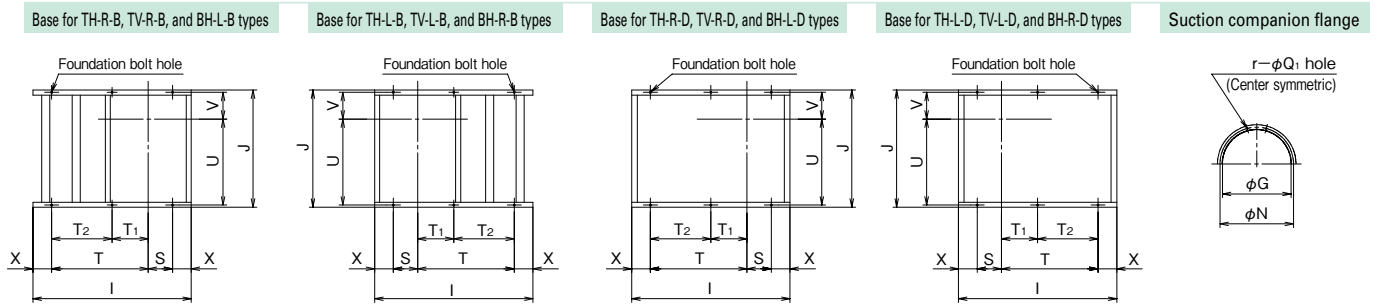

* This drawing shows a view from the V-pulley side.

Size table

(Unit: mm)

Symbol No.	Main body										Bearings	Maximum rotation speed min ⁻¹	Suction companion flange				Discharge companion flange				
	A	B	C	E ₁	H ₁	H ₂	H ₃	L	O	ϕG			ϕN	$r-\phi Q_1$	Shaped steel size	E	K	$P_1 \times n_1$	$P_2 \times n_2$	$n-\phi Q_2$	Shaped steel size
3½	440	492	414	285	440	510	645	194	785	UCP308	1000	550	590	12- $\phi 12$	L40×40×3	570	385	75.5×8	84×5	26- $\phi 12$	L30×30×3
4	510	560	471	325	490	580	730	222	857	UCP309	855	630	670	16- $\phi 12$	L40×40×5	650	440	87×8	97×5	26- $\phi 12$	L40×40×5

Symbol No.	Base														Motor output kW	Approx. mass (not including motor) kg									
	I		J		S		T		T ₁	T ₂	U	V	X			h	h ₁	h ₂		B/D-type foundation bolt hole	I/G-type ceiling suspension bolt hole	B-type	D-type	I-type	G-type
	B/D-type	I/G-type	B/D-type	I/G-type	B/D-type	I/G-type	B/D-type	I/G-type					B/D-type	I/G-type		B/D-type		I/G-type	B/D-type						
3½	1080	1350	940	195	490	585	760	-	-	690	215	150	50	65	65	18	65	75	4- $\phi 15$	4- $\phi 19$	0.75~7.5	200	215	225	225
	1270	1540				-	950	290	485										6- $\phi 15$	4- $\phi 19$	11~15	205	225	230	230
4	1100	1400	1040	240	565	560	735	-	-	762.5	242.5	150	50	75	75	18	75	75	4- $\phi 15$	4- $\phi 24$	1.5~7.5	270	295	295	295
	1410	1710				-	1045	315	555										6- $\phi 15$	4- $\phi 24$	11~18.5	295	335	335	335

* D-type (floor, anti-vibration type) is drawn in solid lines. Assume that B-type (with common base) is up to the common base.

I-type (ceiling-suspended, anti-vibration mount type) and G-type (anti-vibration hanger type) are drawn in chain double-dashed lines.

Assembly drawing (No. 4½ – 6)

Base for TH-R-B, TV-R-B, and BH-L-B types

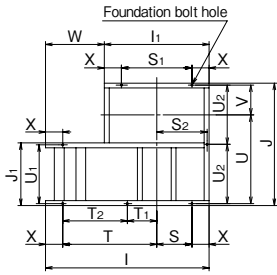

Base for TH-L-B, TV-L-B, and BH-R-B types

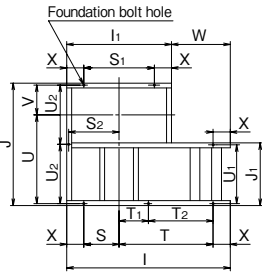

Base for TH-R-D, TV-R-D, and BH-L-D types

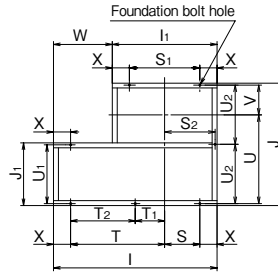

Base for TH-L-D, TV-L-D, and BH-R-D types

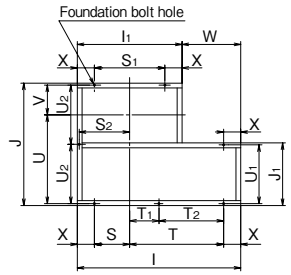

TH-R type

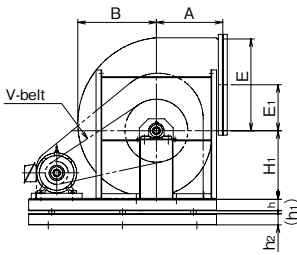

BH-R type

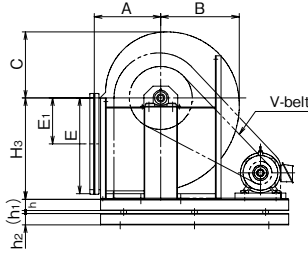

TV-R type

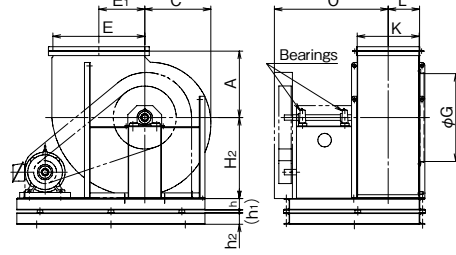

TH-L type

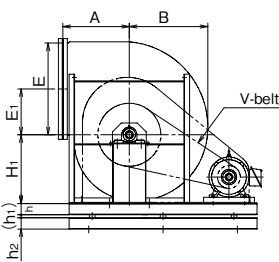

BH-L type

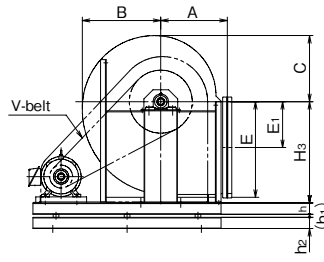

TV-L type

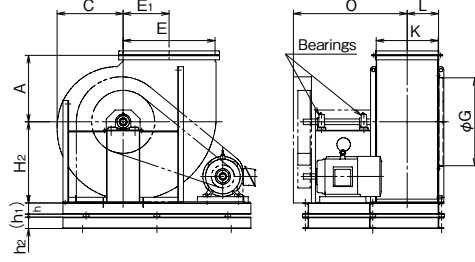

Suction companion flange

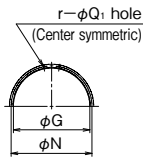

Discharge companion flange

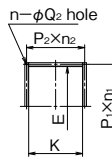

* This drawing shows a view from the V-pulley side.

Size table

(Unit: mm)

No.	Main body										Bearings	Maximum rotation speed min ⁻¹	Suction companion flange				Discharge companion flange				
	A	B	C	E ₁	H ₁	H ₂	H ₃	L	O	phi G			phi N	r-phi Q ₁	Shaped steel size	E	K	P ₁ xN ₁	P ₂ xN ₂	n-phi Q ₂	Shaped steel size
4½	550	629	530	365	550	650	820	251	910	UCP309	780	710	750	16-phi 12	L40x40x5	730	495	97x8	90x6	28-phi 12	L40x40x5
5	590	698	587	407.5	610	720	900	278	1010	UCP310	675	780	825	16-phi 15	L40x40x5	815	550	86x10	99x6	32-phi 12	L40x40x5
5½	650	767	645	447.5	665	790	980	306	1082	UCP311	615	860	905	16-phi 15	L40x40x5	895	605	94x10	93x7	34-phi 12	L40x40x5
6	700	835	703	487.5	730	860	1060	333	1135	UCP311	535	935	980	16-phi 15	L40x40x5	975	660	85x12	88x8	40-phi 15	L40x40x5

No.	Base																	B/D-type foundation bolt hole	Motor output kW	Approx. mass (not including motor) kg			
	I	I ₁	J	J ₁	S	S ₁	S ₂	T	T ₁	T ₂	U	U ₁	U ₂	V	W	X	h			h ₁	h ₂	B-type	D-type
4½	1300	990	1120	560	320	640	477.5	630	-	-	805	525	542.5	280	310	175	75	18	75	6-phi 15	1.5~7.5	355	395
	-							305	625	7-phi 15										11~22		360	405
5	1350	1070	1250	640	360	720	515	640	-	-	905	600	605	305	280	175	100	27	100	6-phi 19	2.2~11	445	505
	1670							-	300	660					7-phi 19					15~22		455	520
	1400							-	300	690					6-phi 19					2.2~15		580	640
5½	1780	1180	1350	685	390	780	570	610	-	-	977.5	645	655	332.5	220	200	100	27	100	6-phi 19	18.5~30	590	660
	1500							-	110	550					7-phi 19					2.2~15		655	720
6	1900	1280	1430	710	440	880	620	-	-	-	1030	670	695	360	220	200	100	27	100	7-phi 19	18.5~30	665	740
	-							-	310	750					6-phi 19					18.5~30		665	740

* D-type (floor, anti-vibration type) is drawn in solid lines. Assume that B-type (with common base) is up to the common base.

Assembly drawing (No. 6½ – 10)

Base for TH-R-B, TV-R-B, and BH-L-B types

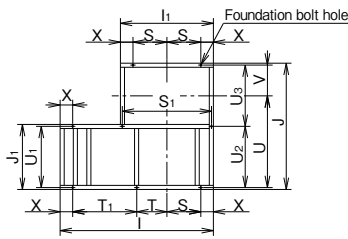

Base for TH-L-B, TV-L-B, and BH-R-B types

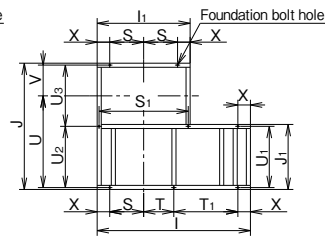

Base for TH-R-D, TV-R-D, and BH-L-D types

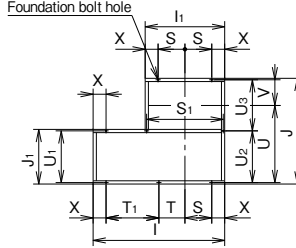

Base for TH-L-D, TV-L-D, and BH-R-D types

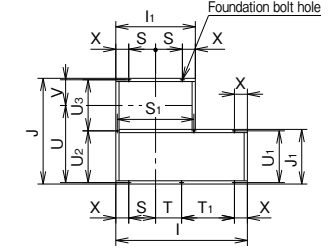

TH-R type

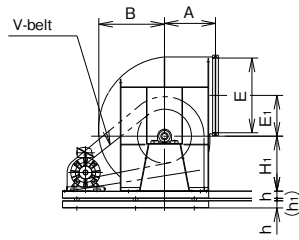

BH-R type

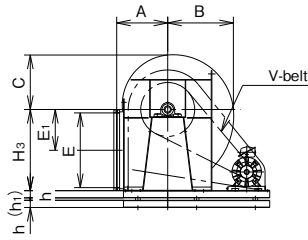

TV-R type

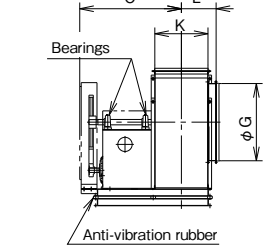
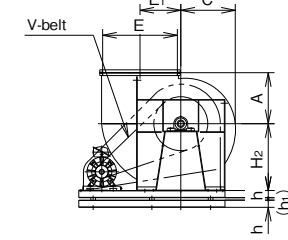

TH-L type

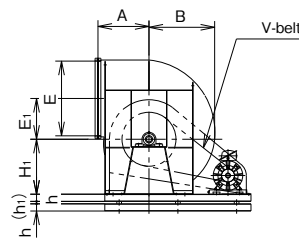

BH-L type

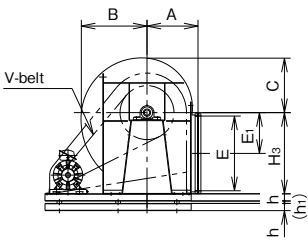

TV-L type

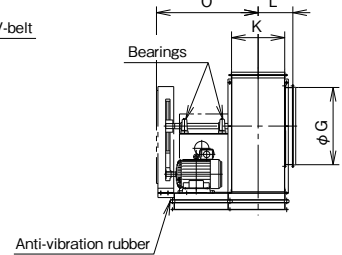
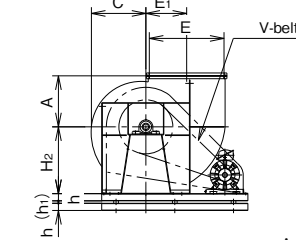

Flanges for No. 6½, 7, 8, 9, and 10

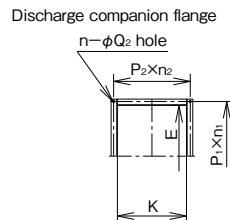
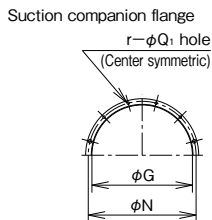

* This drawing shows a view from the V-pulley side.

Size table

(Unit: mm)

Symbol No.	Main body										Bearings	Maximum rotation speed min ⁻¹	Suction companion flange				Discharge companion flange				
	A	B	C	E1	H1	H2	H3	L	O	phi G			phi N	r-phi Q	Shaped steel size	E	K	P1 x n1	P2 x n2	n-phi Q	Shaped steel size
6½	710	919	762	568	765	930	1130	483	1416	UCP 315	460	1075	1120	20-15	L40x40x3	1040	740	181x6	196x4	20-15	L40x40x3
7	760	989	820	613	835	990	1230	513	1546	UCP 317	420	1160	1205	20-15	L40x40x3	1120	800	194x6	169x5	22-15	L40x40x3
8	865	1107	922	673	930	1125	1385	578	1691	UCP 319	380	1320	1380	24-19	L50x50x4	1270	910	190x7	194x5	24-19	L50x50x4
9	970	1255	1040	780	1045	1260	1550	653	1896	UCP 322	340	1475	1535	24-19	L50x50x4	1425	1020	186x8	180x6	28-19	L50x50x4
10	1080	1389	1159	838	1175	1420	1730	718	2151	UCP 326	300	1665	1725	32-19	L50x50x4	1610	1150	186x9	173x7	32-19	L50x50x4

Symbol No.	Base															Motor output kW	Approx. mass (not including motor) kg			
	I	I1	J	J1	S	S1	T	T1	U	U1	U2	U3	V	X	h		h1	Foundation bolt hole	B-type	D/I-type
6½	2035	1230	1635	845	415	-	402.5	817.5	1192.5	800	-	-	397.5	200	100	34	6-phi 19	2.2~37	1050	1140
7	2260	1320	1810	945	460	-	470	930	1315	885	-	-	435	200	125	45	6-phi 24	3.7~45	1320	1460
8	2440	1480	2010	1035	540	1420	480	1020	1460	975	975	975	490	200	125	45	8-phi 24	5.5~55	1710	1910
9	2720	1650	2260	1175	575	1580	535	1110	1650	1105	1105	1085	540	250	150	55	8-phi 24	5.5~75	2650	2960
10	2920	1830	2570	1345	665	1760	545	1210	1885	1275	1275	1225	615	250	150	55	8-phi 28	7.5~75	3620	3960

* D-type (floor, anti-vibration type) is drawn in solid lines. Assume that B-type (with common base) is up to the common base. No. 10 has vertical split casing.

Internal structure drawing (No. 3½ - 6)

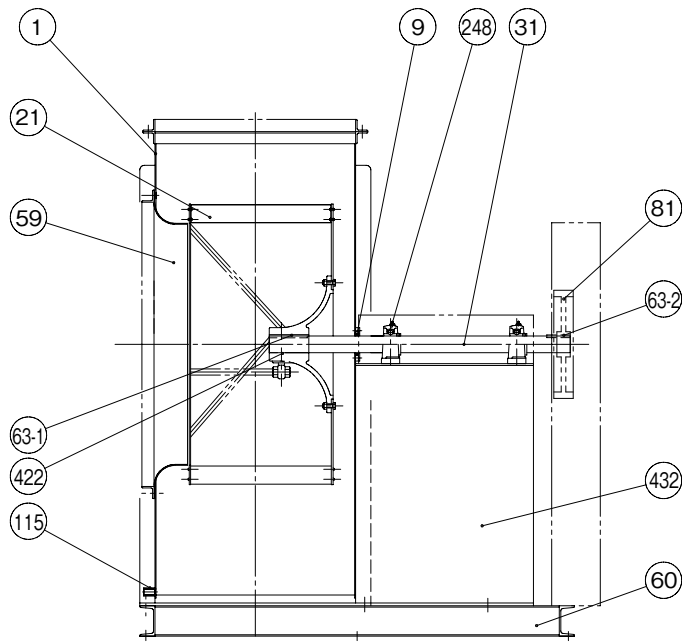

No.	Part name	Qty	Material
1	Casing	1	SPHC · SS400
21	Impeller	1	SPHC · SS400
422	Impeller hub	1	FC200
63-1	Impeller key	1	S45C
59	Inlet	1	SPHE
31	Shaft	1	S45C
432	Bearing stand	1	SPHC
63-2	V-pulley key	1	S45C
81	V-pulley	1	FC200
60	Common base	1	SS400
115	Drain	1	SS400
9	Shaft seal	1	

No.	Part name	Qty	Material	No.3½	No.4	No.4½	No.5	No.5½	No.6
248	Pillow block	2	SUJ	UCP308	UCP309	UCP309	UCP310	UCP311	UCP311

⑨ shaft seal is a special accessory.

Internal structure drawing (No. 6½ - 10)

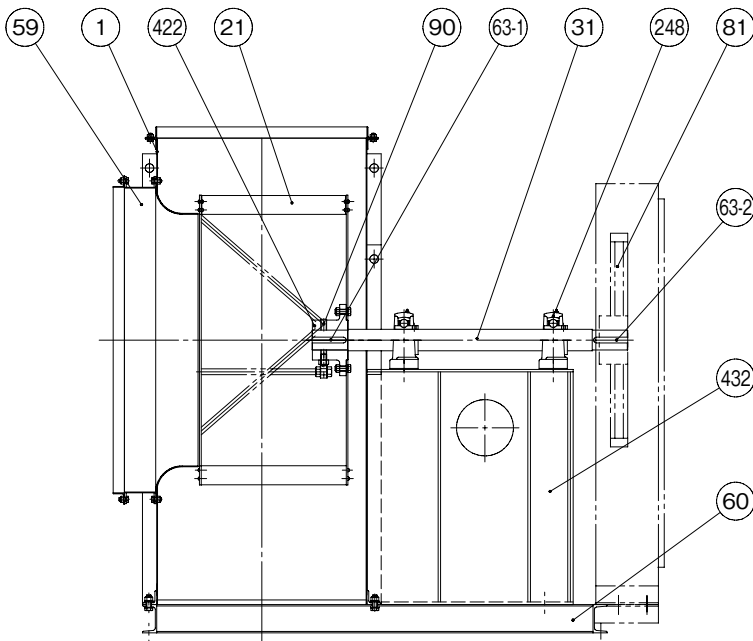

No.	Part name	Qty	Material
1	Casing	1	SS400 · SPHC
21	Impeller	1	SS400 · SEHC
422	Impeller hub	1	FC200
90	Impeller fixing bolt	2	SWCH
63-1	Impeller key	1	S45C
59	Inlet	1	SS400 · SPHC
31	Shaft	1	S45C
432	Bearing stand	1	SS400
81	V-pulley	1	FC200
63-2	V-pulley key	1	S45C
60	Common base	1	SS400

No.	Part name	Qty	Material	No.6½	No.7	No.8	No.9	No.10
248	Pillow block	2	SUJ	UCP315	UCP317	UCP319	UCP322	UCP326

Assembly drawing (No. 1)

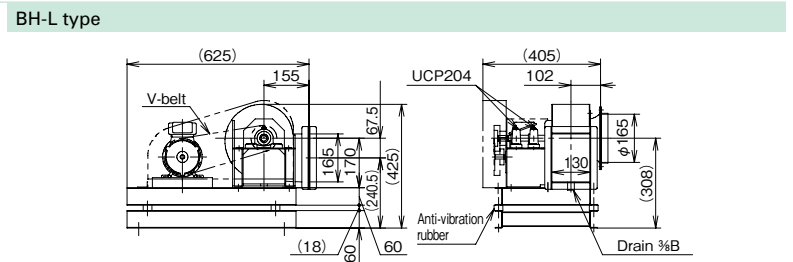
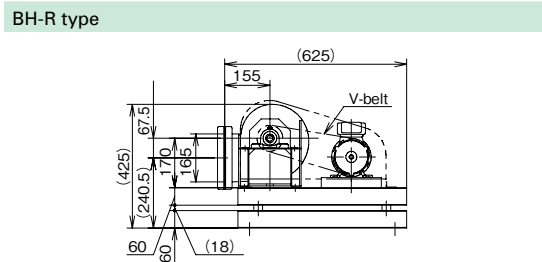
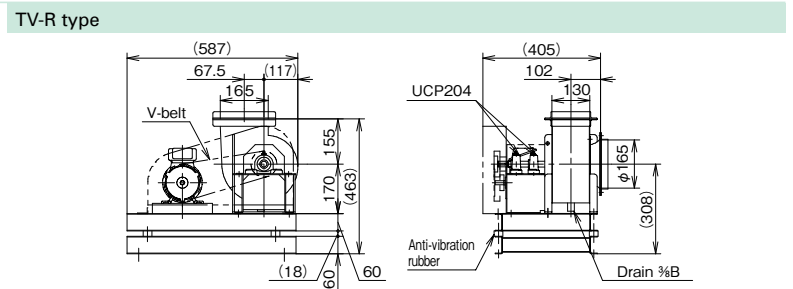
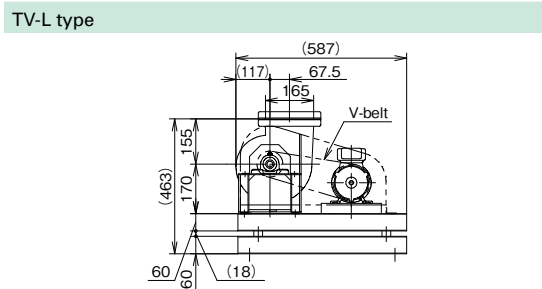
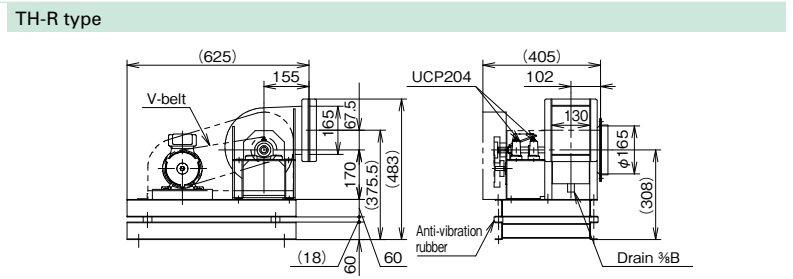
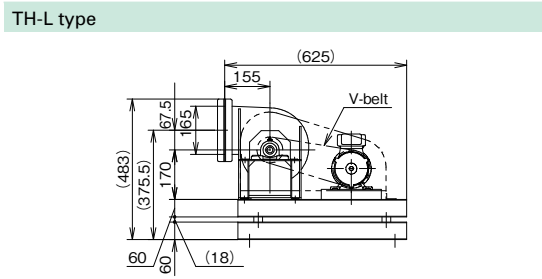
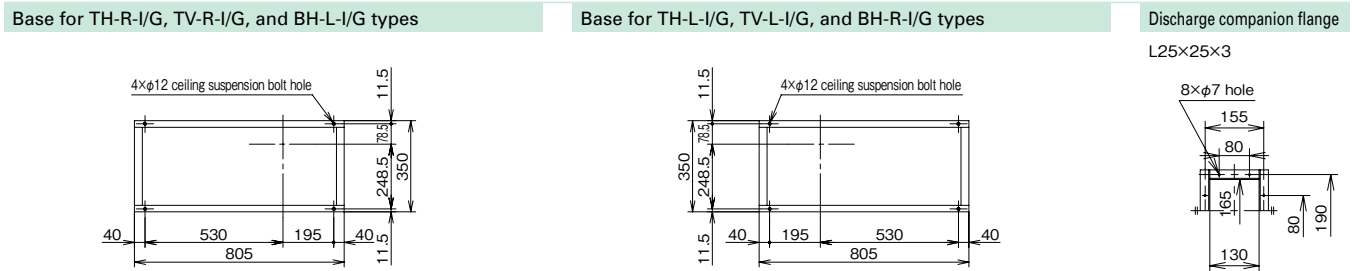
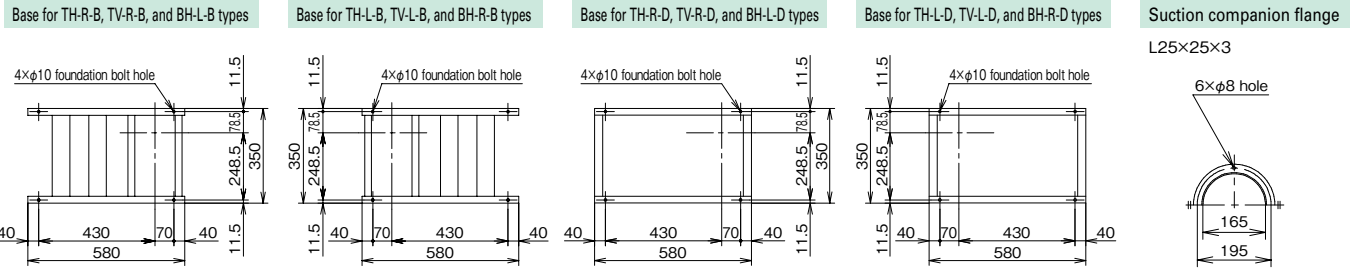

* This drawing shows a view from the V-pulley side.
* This drawing is of a D-type. For a B-type (with common base), assume that there is no anti-vibration base.

* Motor output 0.2 – 0.4kW
* Maximum rotation speed 2550min⁻¹

Approx. mass (not including motor)
B-type : 25kg
D-type : 30kg
I-type : 30kg
G-type : 30kg

Assembly drawing (No. 1 ¼ - 3)

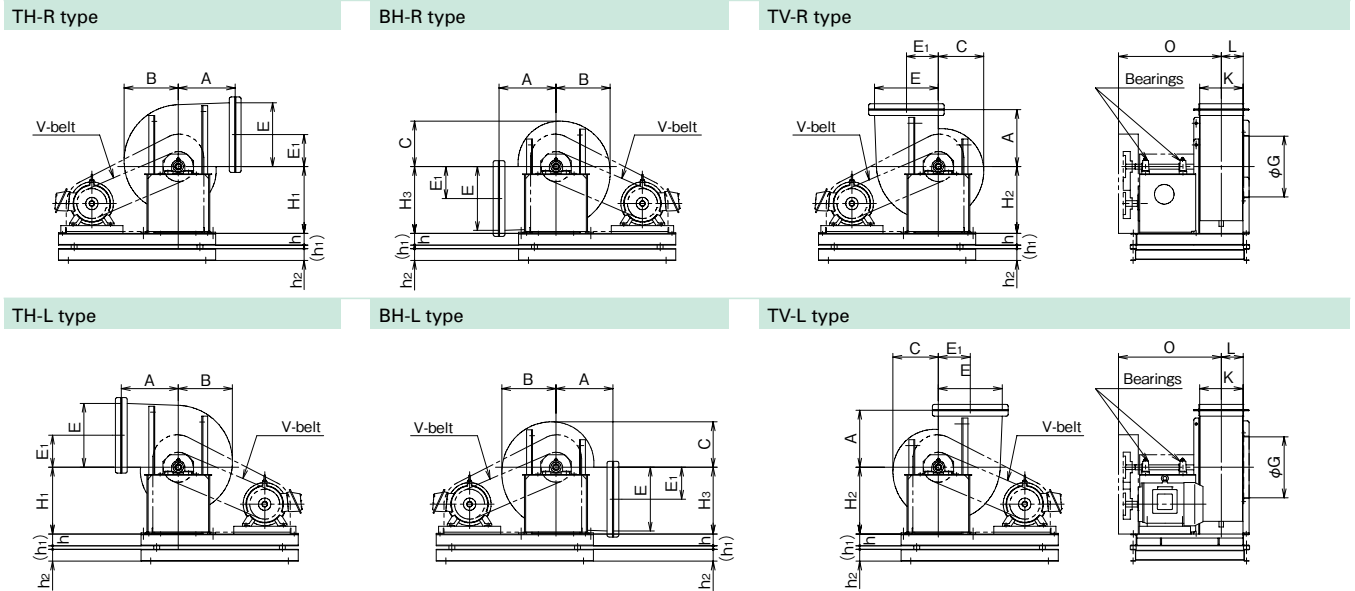
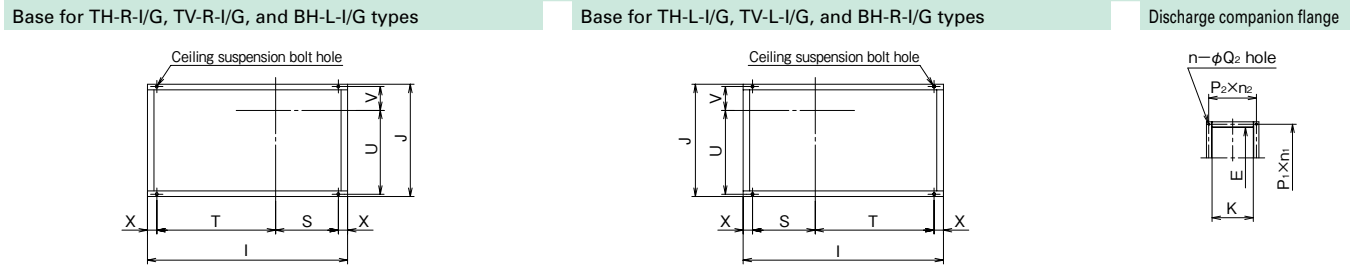
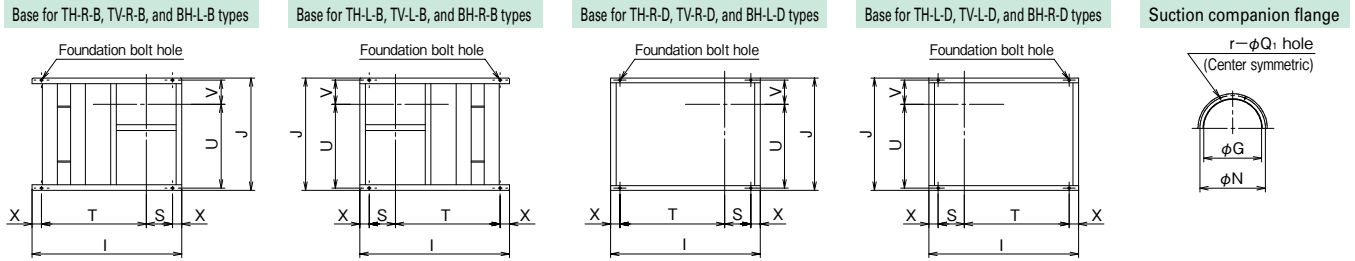

* This drawing shows a view from the V-pulley side.

Size table

(Unit: mm)

Symbol No.	Main body									Bearings	Maximum rotation speed min ⁻¹	Suction companion flange				Discharge companion flange					
	A	B	C	E ₁	H ₁	H ₂	H ₃	L	O			φG	φN	r-φQ1	Shaped steel size	E	K	P ₁ xN ₁	P ₂ xN ₂	n-φQ2	Shaped steel size
1 ¼	232.5	200	175	101	240	240	240	91	426	UCP204	2440	235	262	8-φ8	L25x25x3	248	180	95x3	72x3	12-φ7	L30x30x3
1 ½	232.5	200	175	101	240	240	240	91	426	UCP204	2360	235	262	8-φ8	L25x25x3	248	180	95x3	72x3	12-φ7	L30x30x3
1 ¾	290	276	231	162.5	340	340	340	112	522	UCP205	2070	310	350	8-φ10	L30x30x3	325	220	90x4	85x3	14-φ10	L30x30x3
2	290	276	231	162.5	340	340	340	112	522	UCP205	1730	310	350	8-φ10	L30x30x3	325	220	90x4	85x3	14-φ10	L30x30x3
2 ½	330	344	289	202.5	420	420	420	139	635	UCP306	1340	400	435	8-φ10	L30x30x3	405	275	88x5	78x4	18-φ10	L30x30x3
3	390	413	347	242.5	380	440	550	167	702	UCP307	1110	480	515	12-φ12	L30x30x3	485	330	87x6	73x5	22-φ12	L30x30x3

Symbol No.	Base												Motor output kW	Approx. mass (not including motor) kg											
	I		J	S		T		U		V		h		h ₁	h ₂	B/D-type foundation bolt hole	I/G-type ceiling suspension bolt hole	B-type	D-type	I-type	G-type				
B/D-type	I/G-type	B/D-type		I/G-type	B/D-type	I/G-type	B/D-type	I/G-type	B/D-type	I/G-type	B/D-type	I/G-type	B/D-type									I/G-type			
1 ¼	680	910	500	90	275	490	555	368.5	368.5	108.5	108.5	50	40	60	60	18	60	60	4-φ10	4-φ12	0.2~1.5	45	50	50	50
1 ½	680	910	500	90	275	490	555	368.5	368.5	108.5	108.5	50	40	60	60	18	60	60	4-φ10	4-φ12	0.2~2.2	45	50	50	50
1 ¾	800	1070	600	140	335	560	635	448.5	447.5	128.5	127.5	50	50	60	60	18	60	65	4-φ12	4-φ15	0.2~3.7	75	80	85	85
2	800	1070	600	140	335	560	635	448.5	447.5	128.5	127.5	50	50	60	65	18	60	65	4-φ12	4-φ15	0.4~3.7	75	80	85	85
2 ½	850	1120	730	130	375	520	645	550	550	155	155	100	50	65	65	18	65	65	4-φ12	4-φ15	0.4~3.7	110	115	120	120
	960	1230				630	755														5.5~7.5	110	120	125	125
3	980	1250	840	200	445	580	705	617.5	617.5	187.5	187.5	100	50	65	65	34	65	75	4-φ15	4-φ19	0.75~5.5	145	155	165	165
	1130	1400				730	855														7.5~11	165	175	185	185

* For No. 3 ½ or higher, assembly drawings for standard materials and for gas contact parts made of SUS are identical.

Internal structure drawing (No. 1¼ - 1½)

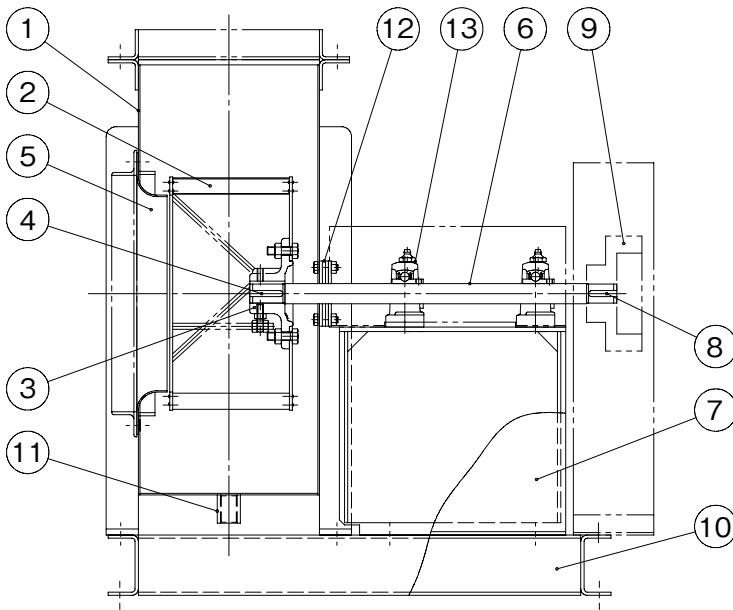

No.	Part name	Qty	Material
1	Casing	1	SUS304
2	Impeller	1	SUS304
3	Impeller hub	1	SCS13
4	Impeller key	1	SUS304
5	Inlet	1	SUS304
6	Shaft	1	SUS304
7	Bearing stand	1	SPHC
8	V-pulley key	1	S45C
9	V-pulley	1	FC200
10	Common base	1	SPHC · SS400
11	Drain	1	SUS304
12	Shaft seal	1	

No.	Part name	Qty	Material	No.1¼ · 1½
13	Pillow block	2	SUJ	UCP204

Ⓔ shaft seal is a special accessory.

Internal structure drawing (No. 1¾ - 3)

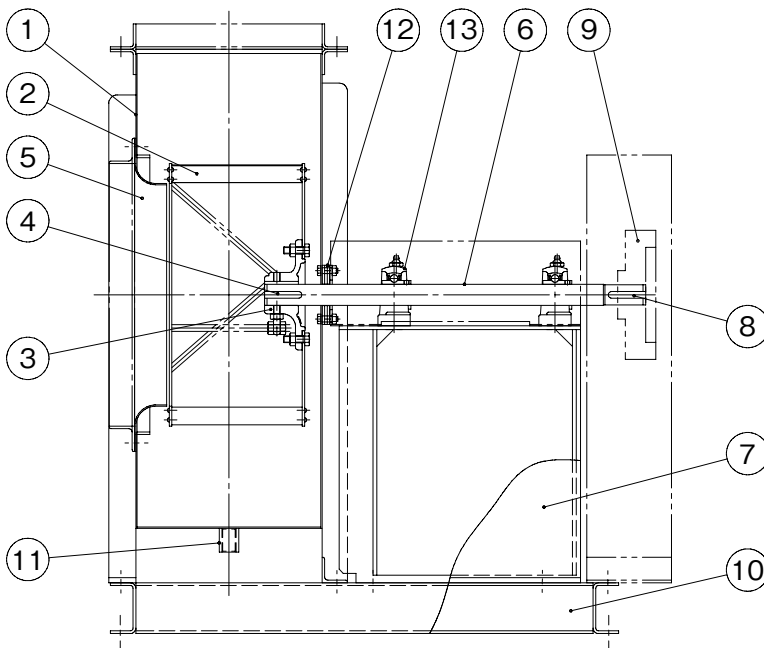

No.	Part name	Qty	Material
1	Casing	1	SUS304
2	Impeller	1	SUS304
3	Impeller hub	1	SCS13
4	Impeller key	1	SUS304
5	Inlet	1	SUS304
6	Shaft	1	SUS304
7	Bearing stand	1	SPHC
8	V-pulley key	1	S45C
9	V-pulley	1	FC200
10	Common base	1	SPHC · SS400
11	Drain	1	SUS304
12	Shaft seal	1	

No.	Part name	Qty	Material	No.1¾ · 2	No.2½	No.3
13	Pillow block	2	SUJ	UCP205	UCP306	UCP307

Ⓔ shaft seal is a special accessory.

Assembly drawing (No. 2 - 4)

Base for TH-R-B, TV-R-B, and BH-L-B types

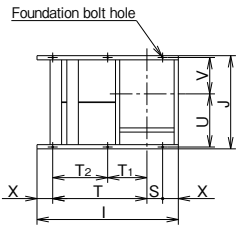

Base for TH-L-B, TV-L-B, and BH-R-B types

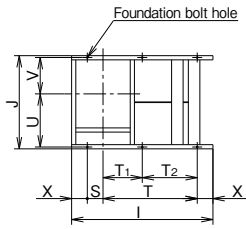

Base for TH-R-D, TV-R-D, and BH-L-D types

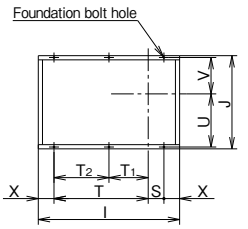

Base for TH-L-D, TV-L-D, and BH-R-D types

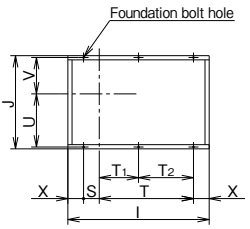

Base for TH-R-I, TV-R-I, and BH-L-I types

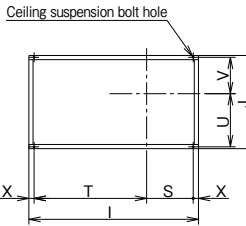

Base for TH-L-I, TV-L-I, and BH-R-I types

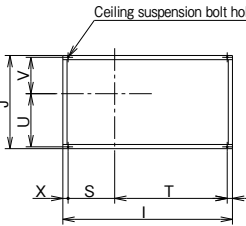

Base for TH-R-G, TV-R-G, and BH-L-G types

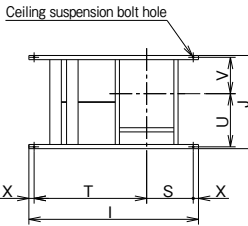

Base for TH-L-G, TV-L-G, and BH-R-G types

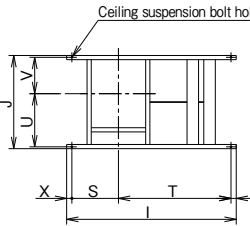

Discharge companion flange

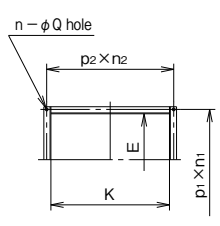

TH-R type

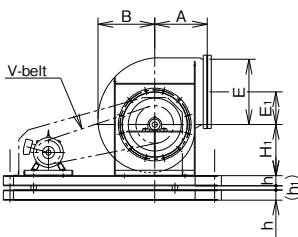

BH-R type

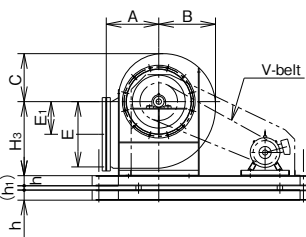

TV-R type

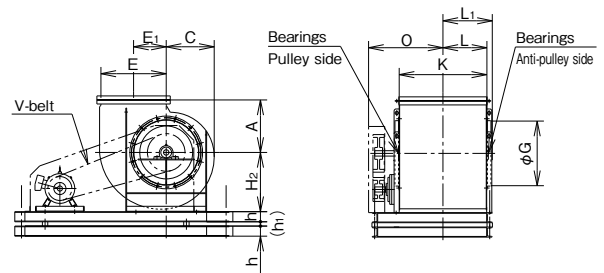

TH-L type

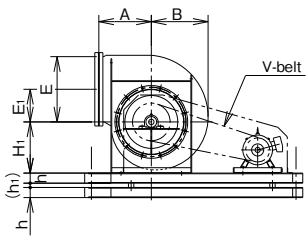

BH-L type

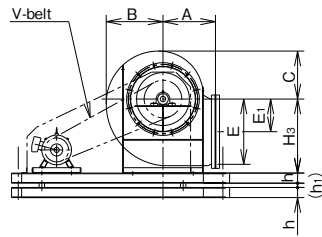

TV-L type

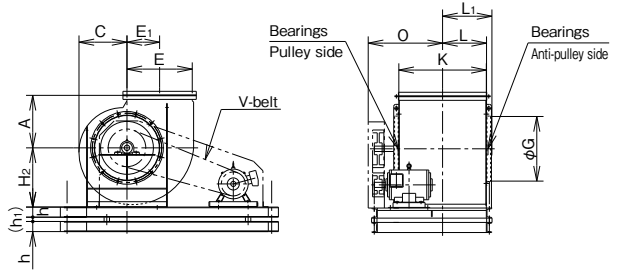

* This drawing shows a view from the V-pulley side.

Size table

(Unit: mm)

Symbol No.	Main body										Bearings		Maximum rotation speed min ⁻¹	Discharge companion flange						
	A	B	C	E ₁	φG	H ₁	H ₂	H ₃	L	L ₁	O	Pulley side		Anti-pulley side	E	K	P1×n1	P2×n2	n-φQ	Shaped steel size
2	290	285	240	162.5	310	290	290	380	212	249	415	For bearings, see the internal structure drawing.	1580	325	420	89×4	90×5	18-10	L25×25×3	
													1730							
2½	330	350	295	202.5	400	365	365	460	272	315	515		1340	405	540	87×5	95×6	22-10	L25×25×3	
3	390	420	355	242.5	480	380	440	550	327	367	595		1030	485	650	87×6	98×7	26-12	L30×30×3	
													1110							
3½	440	490	415	285	550	440	510	645	379	430	680		850	570	755	75.5×8	99×8	32-12	L30×30×3	
													1000							
4	510	560	470	325	630	490	580	730	427	478	715		790	650	850	87×8	89.5×10	36-12	L40×40×5	
													855							

Symbol No.	Base												Motor output kW	Approx. mass (not including motor) kg								
	I		J	S		T		T ₁	T ₂	U	V	X		h	h ₁	Foundation bolt hole	Ceiling suspension bolt hole	B-type	D-type	I-type	G-type	
B/D-type	I/G-type	B/D-type		I/G-type	B/D-type	I/G-type	B/D-type					I/G-type	B/D-type									I/G-type
2	1140	1310	590	90	335	750	875	-	-	337.5	227.5	100	50	65	18	4-φ12	4-φ15	0.75~3.7	73	78	83	75
	1150	1420				820	945	-	-	427.5	287.5	100	50	65	18	4-φ12	4-φ15	5	75	80	86	77
2½	1250	1520	740	130	375	920	1045	-	-	507.5	347.5	150	50	75	18	4-φ15	4-φ19	0.75~7.5	105	110	117	107
																		11	110	115	122	112
3	1350	1620	890	150	445	900	1075	-	-	507.5	347.5	150	50	75	18	4-φ15	4-φ19	1.5~7.5	160	170	195	175
	1430	1700				1110	370	565										11~15	170	180	205	185
3½	1500	1770	1020	195	490	-	1180	405	600	585	400	150	50	75	18	6-φ15	4-φ19	1.5~11	210	225	245	225
	1570	1870				1205	395	635										15~22	230	250	270	240
4	1650	1950	1100	240	565	-	1285	435	675	617.5	447.5	150	50	75	18	6-φ15	4-φ24	2.2~15	280	295	320	300
																		18.5~30	320	340	360	330

* D-type (floor, anti-vibration type) is drawn in solid lines. Assume that B-type (with common base) is up to the common base. I-type (ceiling-suspended, anti-vibration mount type), and G-type (anti-vibration hanger type) are drawn in chain double-dashed lines.

Assembly drawing (No. 4½ - 6)

Base for TH-R-B, TV-R-B, and BH-L-B types

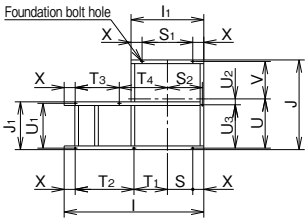

Base for TH-L-B, TV-L-B, and BH-R-B types

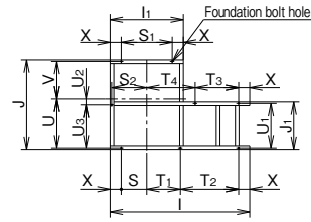

Base for TH-R-D, TV-R-D, and BH-L-D types

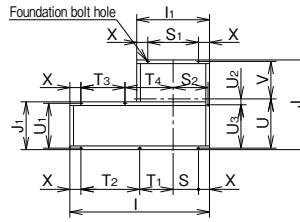

Base for TH-L-D, TV-L-D, and BH-R-D types

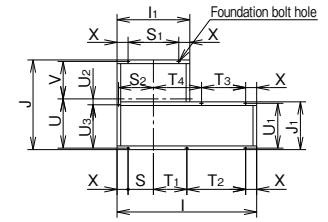

TH-R type

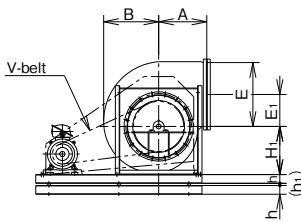

BH-R type

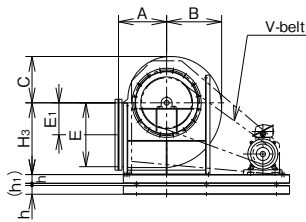

TV-R type

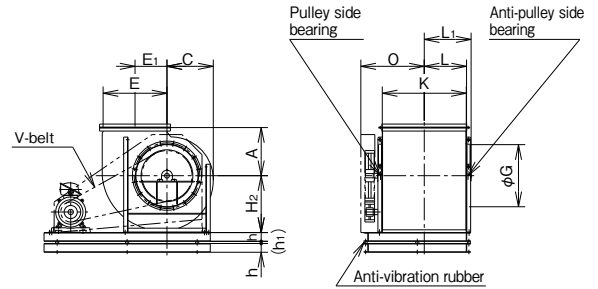

TH-L type

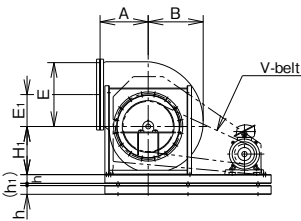

BH-L type

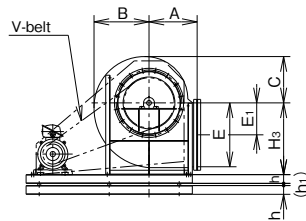

TV-L type

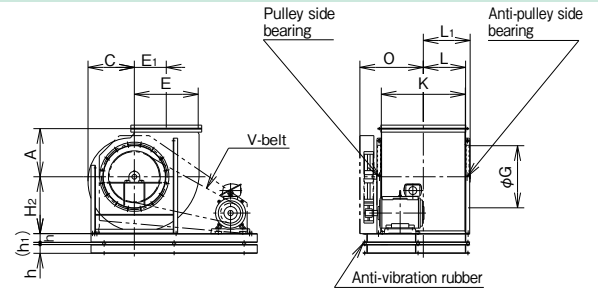

Discharge companion flange

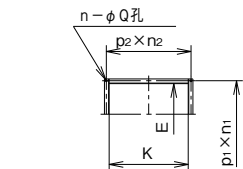

* This drawing shows a view from the V-pulley side.

Size table

(Unit: mm)

Symbol No.	Main body										Bearings		Maximum rotation speed min ⁻¹	Discharge companion flange						
	A	B	C	E ₁	φG	H ₁	H ₂	H ₃	L	L ₁	O	Pulley side		Anti-pulley side	E	K	P ₁ ×n ₁	P ₂ ×n ₂	n-φQ	Shaped steel size
4½	550	630	530	365	710	550	650	820	484	536	785	For bearings, see the internal structure drawing.	710	780	730	960	97×8	84×12	40-12	L40×40×5
5	590	700	590	407.5	780	610	720	900	536	599	865		625	675	815	1065	86×10	92.5×12	44-12	L40×40×5
5½	650	770	645	447.5	860	665	790	980	591	651	915		560	615	895	1175	94×10	94×13	46-12	L40×40×5
6	700	835	705	487.5	935	730	860	1060	646	706	970		535		975	1285	85×12	95×14	52-15	L40×40×5

Symbol No.	Base															Motor output		Approx. mass (not including motor) kg					
	I	I ₁	J	J ₁	S	S ₁	S ₂	T ₁	T ₂	T ₃	T ₄	U	U ₁	U ₂	U ₃	V	X	h	h ₁	Foundation bolt hole	kW	B-type	D-type
4½	1770	990	1220	650	345	690	475	390	735	600	525	670	610	80	590	510	150	100	18	8-φ19	2.2~18.5	410	450
	455							800	600	655													
5	1880	1070	1350	650	360	720	515	405	765	600	570	747.5	610	92.5	655	562.5	175	100	27	8-φ19	3.7~22	510	565
	2000							465	825	600	690												
5½	2050	1180	1480	700	415	830	560	435	850	650	635	797.5	640	87.5	710	622.5	175	125	27	8-φ24	3.7~30	655	755
	2150							485	900	650	735												
6	2150	1280	1590	750	465	930	610	435	900	650	685	852.5	690	87.5	765	677.5	175	125	27	8-φ24	5.5~37	870	980
	2300							510	975	700	785												

* This drawing is of a D-type (floor, anti-vibration type). B-type (with common base) is up to the common base, without an anti-vibration base.

Assembly drawing (No. 6½ - 10)

Base for TH-R, TV-R, and BH-L types

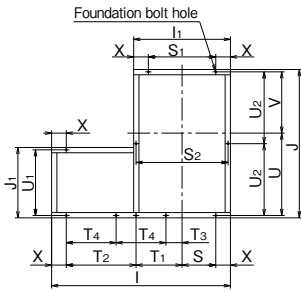

Base for TH-L, TV-L, and BH-R types

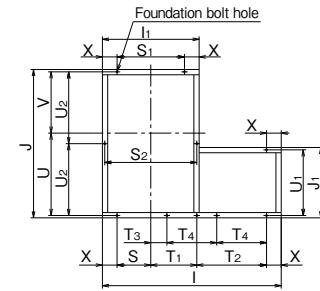

TH-R type

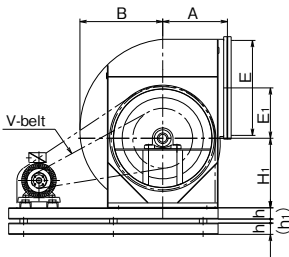

BH-R type

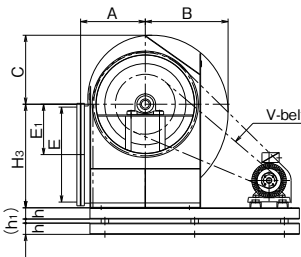

TV-R type

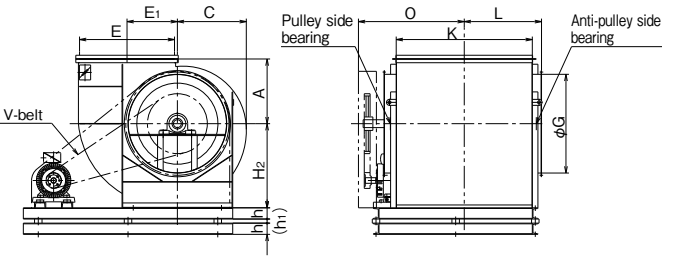

TH-L type

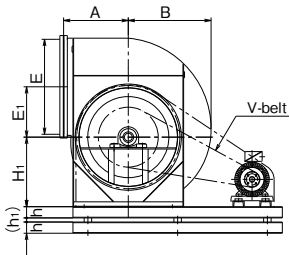

BH-L type

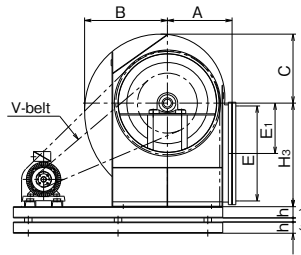

TV-L type

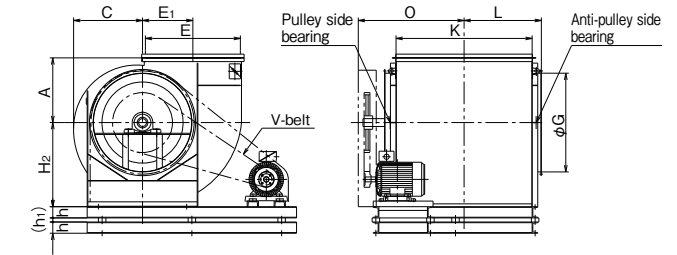

Discharge companion flange

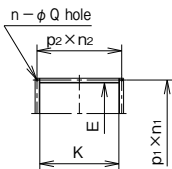

* This drawing shows a view from the V-pulley side.

Size table

(Unit: mm)

Symbol No.	Main body										Bearings		Maximum rotation speed min ⁻¹	Discharge companion flange					
	A	B	C	E1	φG	H1	H2	H3	L	O	Pulley side	Anti-pulley side		E	K	P1×n1	P2×n2	n-φQ	Shaped steel size
6½	710	919	762	568	1075	765	930	1130	853	1277	For bearings, see the internal structure drawing.		440	1040	1480	181×6	191×8	28-φ15	L40×40×3
7	760	989	820	613	1160	835	990	1230	914	1296			420	1120	1600	194×6	183×9	30-φ15	L40×40×3
8	865	1107	922	673	1320	930	1125	1385	1033	1417			360	1270	1820	190×7	188×10	34-φ19	L50×50×4
9	970	1255	1040	780	1475	1045	1260	1550	1173	1655			340	1425	2040	186×8	191×11	38-φ19	L50×50×4
10	1080	1389	1159	838	1665	1175	1420	1730	1303	1807			290	1610	2300	186×9	197×12	42-φ19	L50×50×6

Symbol No.	Base																	Foundation bolt hole	Motor output kW	Approx. mass (not including motor) kg	
	I	I1	J	J1	S	S1	S2	T1	T2	T3	T4	U	U1	U2	V	X	h				h1
6½	2385	1230	1870	750	465	930	1170	465	1155	-	-	1035	690	905	775	150	125	45	8-φ24	11~75	1380
7	2550	1320	1880	800	460	920	1260	615	1075	-	-	985	740	910	835	200	125	45	8-φ24	11~75	1520
8	2800	1480	2200	800	540	1080	1410	660	1200	-	-	1180	730	1065	950	200	150	55	8-φ28	11~90	2260
9	3050	1650	2530	1200	575	1150	1570	-	-	275	850	1405	1120	1225	1045	250	200	55	9-φ28	18.5~90	3400
10	3250	1830	2800	1200	665	1330	1750	-	-	245	920	1535	1120	1360	1185	250	200	55	9-φ28	22~90	4100

* This drawing is of a D-type (floor, anti-vibration type). B-type (with common base) is up to the common base, without an anti-vibration base. No. 10 has vertical split casing.

Internal structure drawing (No. 2 - 4)

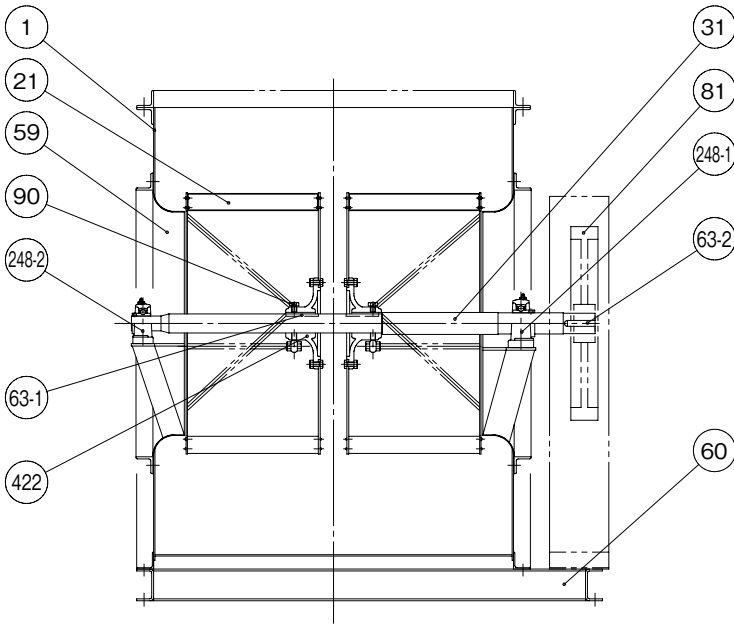

No.	Part name	Qty	Material
1	Casing	1	SPHC · SS400
21	Impeller	1set	SPHC · SS400
422	Impeller hub	1set	FC200
90	Impeller fixing bolt	4	SS400
63-1	Impeller key	2	S45C
59	Inlet	2	SS400 · SPCC
31	Shaft	1	S45C
81	V-pulley	1	FC200
63-2	V-pulley key	1	S45C
60	Common base	1	SS400

No.	Part name	Qty	Material	No.2	No.2½	No.3	No.3½	No.4
248-1	Pillow block	1	SUJ	UCP206 (~3.7kW) UCP307 (~5.5kW)	UCP207 (~3.7kW) UCP308 (~7.5kW) UCP309 (~11kW)	UCP208 (~3.7kW) UCP308 (~7.5kW) UCP310 (~15kW)	UCP209 (~7.5kW) UCP310 (~18.5kW) UCP311 (~22kW)	UCP210 (~7.5kW) UCP310 (~22kW) UCP313 (~30kW)
248-2	Pillow block	1	SUJ	UCP205 (~5.5kW)	UCP206 (~11kW)	UCP206 (~15kW)	UCP207 (~22kW)	UCP207 (~22kW) UCP208 (~30kW)

Values in brackets are maximum motor outputs.

Internal structure drawing (No. 4½ - 6)

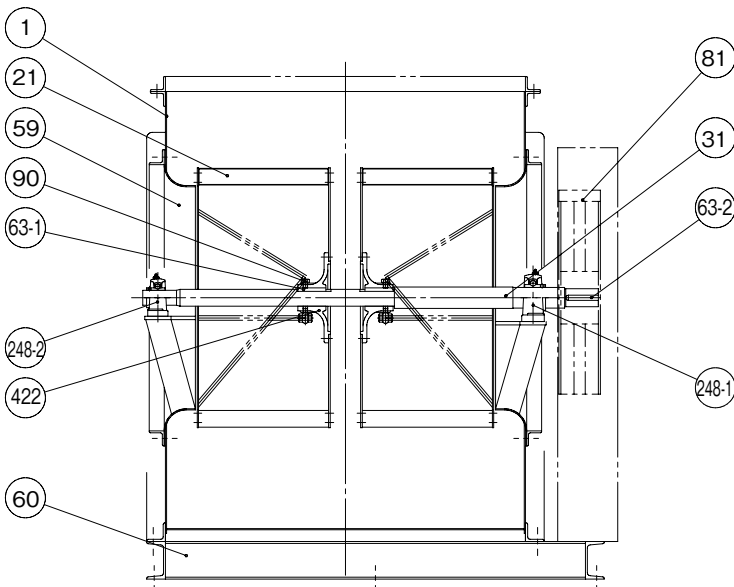

No.	Part name	Qty	Material
1	Casing	1	SPHC · SPCC
21	Impeller	1	SPHC · SPCC
422	Impeller hub	1	FC200
90	Impeller fixing bolt	2	SS400
63-1	Impeller key	1	S45C
59	Inlet	2	SS400 · SPHC
31	Shaft	1	S45C
81	V-pulley	1	FC200
63-2	V-pulley key	1	S45C
60	Common base	1	SS400

No.	Part name	Qty	Material	No.4½	No.5	No.5½	No.6
248-1	Pillow block	1	SUJ	UCP211 (~7.5kW) UCP212 (~15kW) UCP312 (~30kW) UCP315 (~45kW)	UCP212 (~15kW) UCP313 (~37kW) UCP315 (~45kW)	UCP213 (~22kW) UCP313 (~37kW) UCP316 (~55kW)	UCP214 (~22kW) UCP314 (~37kW) UCP316 (~55kW)
248-2	Pillow block	1	SUJ	UCP208 (~30kW) UCP209 (~45kW)	UCP209 (~45kW)	UCP210 (~55kW)	UCP211 (~55kW)

Values in brackets are maximum motor outputs.

MEMO

A series of horizontal dashed lines for writing, spanning the width of the page.

Your Dealer

TERAL

TERAL INC.

Head Office 230, Moriwake, Miyuki-cho, Fukuyama-city, Hiroshima, 720-0003, Japan Tel.+81-84-955-1111 Fax.+81-84-955-5777
www.teral.net

TERAL ASIA LTD.

Room 1001, 10/F, Olympia Plaza, 255 King's Road, North Point, Hong Kong Tel.+852-2571-0886 Fax.+852-2571-0619

TERAL THAI CO., LTD.

TERAL TRADING & SERVICE CO., LTD.

150 Moo 16 Udomsoraryuth Rd., T.Bangkrasan, A.Bangpa-In, Ayutthaya 13160 Thailand Tel.+66-3522-0640 Fax.+66-3522-1259

TERAL GENERAL MACHINE (SHANGHAI) CO., LTD.

No.285, Yuan Qu Road(N), Bei Qiao, Min Hang District, Shanghai 201109, China Tel.+86-21-6490-9128 Fax.+86-21-6490-9126